

LIVEPRO

FOR BETTER PERFORMANCE

2022

CONTACT US

- W** www.livepro-fitness.com
- P** 0086-513-81180020
- F** 0086-513-81180030
- E** sales@liveupsports.com
- A** No.18 Shengli Road,Nantong,China

LIVEARO

2022

**FOR BETTER
PERFORMANCE**

LIVEPRO

NEW FOR 2022

LIVEPRO is a premium fitness brand for functional and performance training, we offer total solution for commercial fitness clubs, boutique studios and professional sports teams. For 16 years, we have provided solutions for more than 4,000 gyms in 100 countries through our distribution partners around the world, our equipment have been widely recognized by users for reliability, professionalism and performance.

Continuous innovation and creative design are in our DNA, this is why we are able to lead the way in fitness industry with our passion in making fitness equipment for better performance. Our ultimate goal is to help customers create best experience for fitness spaces.

Visit us at www.livepro-fitness.com

CONTENTS

- 05-22 FUNCTIONAL
- 23-29 GROUP TRAINING
- 30-54 STRENGTH
- 55-61 STABILITY AND RECOVERY
- 62-63 ENDURANCE TRAINING
- 64-69 BOXING
- 70-71 YOGA PILATES
- 72-79 FLOORING
- 80-83 LIVEPRO GEARS
- 84-95 STORAGE SOLUTION



Training institutions and associations



Brand of cooperating equipment



Professional sports teams



Gym and Studio



Hotels and enterprises



Partners

Customer case

INFINITY

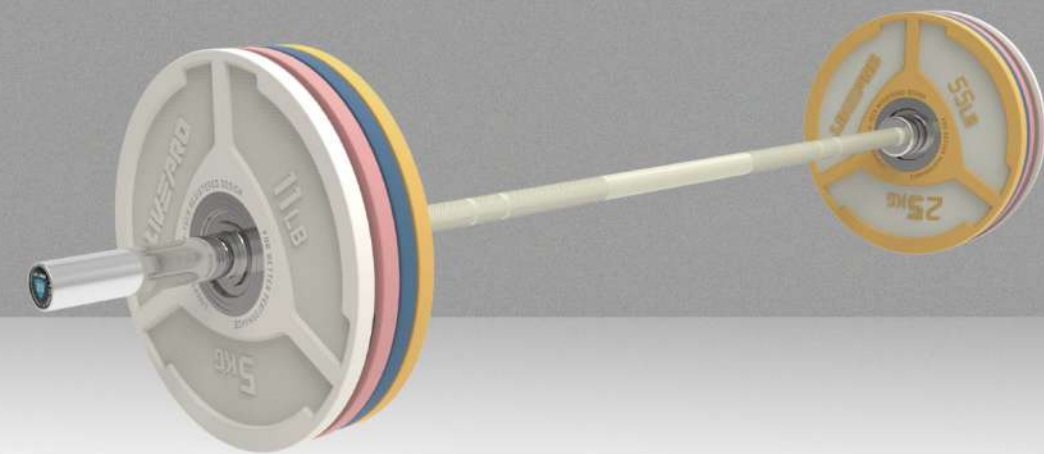

URETHANE DUMBBELLS

- Sold in pairs
- Weight range :2-30kg (increase by 2kg)
- Solid steel core for head, polyurethane wrapped
- Hard chrome handle, 15cm long
- Handle knurled to provide grip
- Welding between handle and head
- Weight error: +/-1%
- matte dirt resistant, patent anti-rolling modeling
- Color: black + white + milk coffee color

ITEM DZVO-1001



URETHANE TRAINING PLATES

- Solid stainless steel inner core
- 3 unique hand gripping hole designs
- Cone handlebar design to avoid pinching fingers
- Precision Casting
- Advanced polyurethane surface coating
- Fashionable milk coffee color

ITEM DZVO-1004



URETHANE BUMPER PLATES

LivePro two-color plates are fixed by an alloy steel core with a diameter of 13cm and a thickness of 7mm to ensure the hardness and stability of the plates. The outer layer is wrapped with high quality polyurethane material with a thickness of 21.5-54.3mm. The plates are waterproof, wear-resistant and can be used for a long time. The plates has unique appearance design and exquisite color matching, in line with IWF standard. After strict fall test, it falls 30000 times from the standard height (except 5KG), and is not easy to appear deformation and damage. Various colors can be selected, each color represents different weight, easy to distinguish and pick up.

ITEM LP8027MO

- Tolerance: +/-1% of claimed weight
- High-quality polyurethane
- Alloy steel blank
- Thinner Ring Piece
- Polyurethane layer thickness:21.5-54.3mm



Plates Item	Color	Weight	Plates Item	Color	Weight
LP8027MO-05	White	5kg	LP8027MO-20	Blue	20kg
LP8027MO-10	Brown	10kg	LP8027MO-25	Yellow	25kg
LP802MO7-15	Red	15kg			

Plates Item	Color	Weight	Shaft diameter	Tested
LP8086MO	Green	15kg	25mm	700LB

LIVEPRO INFINITE SET

PRODUCTS REFERENCE

HANGING CORE MAT (×5)
 BULGARIAN BAG (×3)
 STEEL COMPETIEION KETTLEBELL (×5)
 ANTI-BURST CORE-FIT EXERCISE BALL (×2)
 WALL BALL (×3)
 BALANCE PAD (×4)
 PERFORMANCE ROLLER (×4)
 THE BALANCE TRAINER (×4)
 GAIN[S] (×1)

ITEM LPINF01



LIVEPRO CHERRY BLOSSOM SERIES

PRODUCTS REFERENCE

HANGING CORE MAT (×5)
 BULGARIAN BAG (×3)
 STEEL COMPETIEION KETTLEBELL (×5)
 ANTI-BURST CORE-FIT EXERCISE BALL (×2)
 WALL BALL (×3)
 BALANCE PAD (×4)
 PERFORMANCE ROLLER (×4)
 THE BALANCE TRAINER (×4)
 GAIN[S] (×1)

ITEM LPINF02

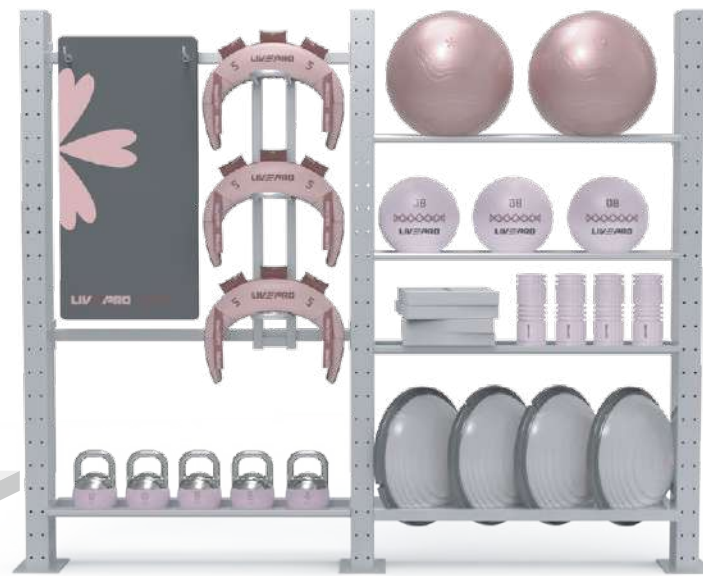

NEW FOR 2022

CUSTOMER INSTALL REFERENCE



LIVEPRO is a premium fitness brand for functional and performance training, we offer total solution for commercial fitness clubs, boutique studios and professional sports teams. For 16 years, we have provided solutions for more than 4,000 gyms in 100 countries through our distribution partners around the world, our equipment have been widely recognized by users for reliability, professionalism and performance.



01

NEW FOR 2022

FUNCTIONAL

www.livepro-fitness.com



FUNCTIONAL



RUBBER KETTLEBELL

This is a kettlebell with stylish design, comfortable and spacious kettlebell handle design, which can be held by one hand or two hands. The groove on the upper part of the sphere is reasonably designed to be more conducive to wrist force. Solid cast iron is molded one time, with natural rubber wrapped, which can effectively protect the core and the floor, with stable center of gravity, strongness and durability.

- Molded in one piece
- Solid high-quality cast iron
- 5mm thick natural rubber layer

Item	Weight	Item	Weight
LP8043-04	4kg	LP8043-16	16kg
LP8043-06	6kg	LP8043-20	20kg
LP8043-08	8kg	LP8043-24	24kg
LP8043-10	10kg	LP8043-28	28kg
LP8043-12	12kg	LP8043-32	32kg



ITEM LP8043

SOLID CAST IRON KETTLEBELL

This is a classic kettlebell designed for heavy use. They use the traditional method of kettlebell design, which means they get larger as the weight increases, allowing for smaller weight kettlebell training. The cast iron is one-off molded and powder coated metal for a stable center of gravity and durability.

- Molded in one piece
- Stable placement
- Classic Design
- Wide ergonomic handle
- Black frosted powder coat

Item	Weight	Item	Weight
LP8041-04	4kg	LP8041-16	16kg
LP8041-06	6kg	LP8041-20	20kg
LP8041-08	8kg	LP8041-24	24kg
LP8041-10	10kg	LP8041-28	28kg
LP8041-12	12kg	LP8041-32	32kg



ITEM LP8041

URETHANE COMPETITION KETTLEBELL

These kettlebells have a steel core, and they are covered by polyurethane material. This material promotes performance advantages in competition by preventing more peeling, scratches, and damage than traditional paint. Polyurethane material composes of a strong gloss texture and is extremely impact resistant. Our polyurethane kettlebell fulfills the standard competition requirements. Sizes of the kettlebell remain the same throughout different weight levels. Lifting technique for each weight level can remain the same as a result of the standard handle and kettlebell size.

- Comply with international standards
- Premium urethane surface coating
- Steel grip (grip diameter: 33mm)
- 8kg-24kg (4kg increments)
- Competition size:
Height: 30cm
Bell diameter: 21cm
Base diameter: 12cm

Item	Weight	Item	Weight
LP8040-08	8kg	LP8040-20	20kg
LP8040-12	12kg	LP8040-24	24kg
LP8040-16	16kg		



ITEM LP8040

STEEL COMPETITION KETTLEBELL

These kettlebells are made of all-steel material, allowing it to retain the performance advantages of competitive kettlebells and prevent rust as compared to traditional cast iron kettlebells. Our design of the all-steel kettlebells conforms to the standard size for competition kettlebells. All sizes are equivalent throughout every weight level. The standard sizing of the handle and kettlebell allows the lifting technique to be the same every time. We designed this kettlebell with a hard chrome surface treatment that will not fall off or rest like other traditional kettlebell coatings.

- Comply with international standards
- Matte paint coating package
- Diameter: 21cm
- Height: 28cm

Item	Weight	Item	Weight
LP8042-04	4kg	LP8042-16	16kg
LP8042-06	6kg	LP8042-20	20kg
LP8042-08	8kg	LP8042-24	24kg
LP8042-10	10kg	LP8042-28	28kg
LP8042-12	12kg	LP8042-32	32kg



ITEM LP8042

CAST-IRON COMPETITION KETTLEBELL

Designed to withstand the brunt of all gym environments and regular use, this Cast iron competition kettlebell is cast from solid iron with a textured powder coat exterior. Different weight specifications have the same size, the kettlebell has a one-piece design. The comfortable grip and sturdy handle are ergonomically designed for a more effective workout. The kettlebell has a flat base at the bottom for easy storage and does not roll easily. High quality color coded for easy identification and differentiation, perfect for use in the gym.

- Premium materials and craft construction
- Comfortable non-slip handle
- Stable placement
- Different weight specifications, same size
- Color coding

Item	Weight	Item	Weight
LP8044-08	8kg	LP8044-20	20kg
LP8044-10	10kg	LP8044-24	24kg
LP8044-12	12kg	LP8044-28	28kg
LP8044-16	16kg	LP8044-32	32kg



ITEM LP8044

www.livepro-fitness.com



WALL BALL

Livepro's wall balls are a kind of medicine ball and the latest strength and functional training tool. Wall balls are very suitable for wall throwing, torso rotation, squatting, sit-ups, presses, and others. Exercises with wall balls improve endurance, explosive power, and core power.

ITEM LP8100

- Non-slip, moisture-proof
- Scratch-resistant PVC
- Diameter:35cm
- Sand and steel shot weighted filler
- Double covered for extra durability
- Take 6000 gravity falls



Item	Weight	Diameter
LP8100-03	3kg	35cm
LP8100-05	5kg	35cm
LP8100-08	8kg	35cm
LP8100-10	10kg	35cm
LP8100-12	12kg	35cm

PRO WALL BALL

- Non-slip, moisture-proof
- Scratch-resistant PVC
- Diameter:35cm
- Sand and steel shot weighted filler
- Double covered for extra durability
- Take 20000 gravity falls

ITEM LP8103



Item	Weight	Item	Weight
LP8103-02	2kg	LP8103-07	7kg
LP8103-03	3kg	LP8103-08	8kg
LP8103-04	4kg	LP8103-10	10kg
LP8103-05	5kg	LP8103-12	12kg
LP8103-06	6kg		

SLAM BALL

The Slam ball is the best equipment for you if you need something to enhance your core, explosive power. This inelastic fitness ball and its non-slip textured surface enhances one's grip even in a humid environment. Therefore, higher explosive power and violent impacts are achieved.

ITEM LP8105

- Unique tire shape and anti-skid texture
- High elasticity
- Take 10,000 gravity falls
- Material: PVC+iron sand



Item	Weight	Item	Weight
LP8105-03	3kg	LP8105-12	12kg
LP8105-05	5kg	LP8105-15	15kg
LP8105-08	8kg	LP8105-20	20kg
LP8105-10	10kg		

DOUBLE GRIP MEDICINE BALL

Livepro's double grip medicine ball not only has all the characteristics of a traditional fitness ball but also a unique binaural grip design. This design provides trainers with more exercise movements. The anti-slip texture on the surface of the medicine ball increases the grip and makes training safer.

ITEM LP8111

- Surface non-slip texture
- All the same dimensions Weight
- Double grip design provides better grip
- High Quality Rubber Material



Item	Weight	Diameter
LP8111-04	4kg	25cm
LP8111-05	5kg	25cm
LP8111-06	6kg	27.5cm
LP8111-07	7kg	27.5cm
LP8111-08	8kg	30cm

MEDICINE BALL

Livepro's medicine balls are the main tool for strength training to enhance core strength, exercise balance, and coordination. Medicine balls are suitable for all kinds of upper and lower body exercises. Athletes can add necessary weight for more diverse strength training such as boat poses, lunges, and Russian twists.

ITEM LP8112

- Blue rubber textured pattern
- Durable natural rubber
- Take 10,000 gravity falls



Item	Weight	Diameter	Item	Weight	Diameter
LP8112-01	1kg	19cm	LP8112-06	6kg	28.6cm
LP8112-02	2kg	19cm	LP8112-07	7kg	28.6cm
LP8112-03	3kg	23cm	LP8112-08	8kg	28.6cm
LP8112-04	4kg	23cm	LP8112-09	9kg	28.6cm
LP8112-05	5kg	23cm	LP8112-10	10kg	28.6cm

TORNADO BALL BAG

The wall ball assist belt can change your wall ball in a few seconds. The original single action can be thrown, slashed, swung, etc. It is also suitable for most sizes of medicine balls.

ITEM LP8101

- It is sewn by a combination of polyester, rubber and PVC. It not only guarantees the durability of the product, but also guarantees the comfort.



SAND BAGS

The energy pack can exercise your whole body strength and enhance your explosive power, hard pull, shoulder press, high lift and deep squat etc. Livepro fillable energy pack trains the whole body in many ways, with 4 bags filled with sand and weighing up to 20kg. The sandbag comes with double Velcro and carrying handle and the sandbag is reinforced with cross-stitching and can easily cope with swinging and other exercises.

ITEM LP8121

- Stable center of gravity
- Heavy reinforced stitching
- High-quality polyester fabric
- Maximum load: 20kg



POWER BAG

Power bag can exercise your whole body strength, enhance your explosive power, hard pull, shoulder press, high lift and deep squat, etc..

ITEM LP8120

- Stable center of gravity
- Cover a layer of EPE pearl cotton
- High-quality PVC material
- High-density thickened NBR rubber handle
- Super load-bearing
- Surface is waterproof, and easy to clean
- 5-25kg

Item	Weight
LP8120-05	5kg
LP8120-10	10kg
LP8120-15	15kg
LP8120-20	20kg
LP8120-25	25kg



BULGARIAN BAG

Bulgarian exercise trains balance, flexibility, strengthens your waist, hands, and legs.

- High Comfort and Stable Center of Gravity
- High quality PVC material
- Surface is Waterproof and Easy to clean
- Super Load Bearing
- 5-22kg
- Size: 67x25cm

Item	Weight
LP8130-05	5kg
LP8130-08	8kg
LP8130-12	12kg
LP8130-17	17kg
LP8130-22	22kg



ITEM LP8130

AQUA BAG

Weight Lifting Aqua bag, loaded with unstable water masses inside, can improve stability, strength and core strength, build up firm muscles and shorten response time. Upon lifting the pack, water will roll from one side to the other, along with a shift in the center of gravity, the trainer's muscles will promptly respond to the shift. This product can attain better workout result than ordinary type. The Aqua bag is made of thickened, eco-friendly PVC, transparent color, sturdy and durable, and easy to clean. It can be readily used when loaded with water, folded and stored when poured out, making it a portable item.

- High-grade PVC material
- Easy to clean
- Easy to fill
- Firm handle
- Improving stability and core strength



ITEM LP8125

5kg



ITEM LP8126

20kg

THE WORM

The Worm can be used to strengthen the sense of teamwork and increase the understanding between players. The Worm builds full body strength and enhances explosive power. The 3m length worm contains 3 padded bags with a zip closure and weighs 75kg. The nylon carry handles are strong and durable and the cross stitching makes it extremely strong and resistant to breakage.

ITEM LP8132

- Environmentally friendly and non-toxic
- Stable centre of gravity
- Anti-slip handles
- Reinforced stitching

- Size: 300x30cm





FUNCTIONAL

STEEL MACE

What differentiates mace training from other "primal" forms of fitness, such as kettlebell or steel club training, is the mace's highly uneven distribution of weight.

ITEM LP8045

- Combine the utility of kettlebells with progressive resistance based on leverage.
- The exercise can be moved forward or backward by changing the posture of the hand.
- Mace training is a great way to develop core strength for powerful, functional exercise.



Item	Weight
LP8045-04	4kg
LP8045-06	6kg
LP8045-08	8kg
LP8045-08	10kg
LP8045-08	12kg

SAND BAG

Sand bags are available in six sizes, with max fill capacities of 20KG, 40KG, 60KG, 80KG, 100KG. Each Sandbag has a built-in filler bag with an additional zipper and hook-and-loop closure—ensuring filler material stays fully contained as you work through your regimen.

ITEM LP8106

- Material: Cordura
- Does not contain filling material

Item	Weight	Size
LP8106-20	20kg	37x10cm
LP8106-40	40kg	37x20cm
LP8106-60	60kg	37x32cm
LP8106-80	80kg	37x38cm
LP8106-100	100kg	37x46cm



ROPE PULLER

The Livepro Rope Puller is based on the simple principle of rock climbing and utilizes a magnetically controlled resistance machine that provides an isometric aerobic workout. People of any age and athletic ability can safely use our rope for training. It has a total of six levels of resistance, and we can change the speed of the rope puller by adjusting the resistance for different fitness purposes to provide maximum resistance training for athletes. The polyurethane material of the rope can provide comfortable grip and reduce friction and slippage during exercise.

ITEM LP8167

- Magnetically controlled resistance
- Comfortable and easy to grip the rope
- Six-gear resistance adjustment
- With simple installation method
- Weight: 4.7kg
- Size: Rope: 400x2.5x1.8cm Host: 20x16cm



TRAINING BARREL

Training barrel encompass the dual effects of aerobic exercise and strength exercise. They train flexibility, balance, and muscle lines better than other ordinary fitness equipment. They are a very effective functional training tool. Many fitness enthusiasts enjoy the durable thermoplastic rubber material and strength functions of this tool.

ITEM LP8140

- High-quality polymer TPR material
- Wide ergonomic handles
- Multiple Specifications and Colors Available

Item	Color	Weight	Size
LP8140-02	Yellow	2kg	73.2x9.7CM
LP8140-04	Purple	4kg	107x13.6CM
LP8140-06	Green	6kg	107x14.2CM
LP8140-08	Cyan	8kg	107x14.2CM
LP8140-10	Red	10kg	107x15.5CM
LP8140-12	Black	12kg	107x15.9CM



SANDBELL

The durable neoprene material is filled with sand, weighs from 2-10kg, and can be used both indoors and outdoors for explosive strength training such as slugging, throwing and tossing.

ITEM LP8225

- Extremely durable neoprene material
- Flowing center of gravity
- Soft material for easy grip

Item	Weight	Size
LP8225-02	2kg	24cm
LP8225-04	4kg	26cm
LP8225-06	6kg	27.5cm
LP8225-08	8kg	29.5cm
LP8225-10	10kg	31.5cm



FUNCTIONAL

TIRE

Tire training can exercise to your whole body, enhance explosive power and strength, and exercise your whole body muscles through jumping, flipping, lifting, pushing and pulling movements to, but the tire itself is relatively unstable. There is a certain control difficulty, so you need to use the correct method to train. The handle on the front and side of the tire is also designed for easy control.

ITEM LP8182

- Durable and not easily deformed
- Waterproof, wear-resistant
- Ergonomic handle
- Cross-stitching process



LP8182-40 40kg

- » Diameter: 88cm
- » The inner diameter: 40cm
- » Height: 25cm



LP8182-60 60kg

- » Diameter: 103cm
- » The inner diameter: 50cm
- » Height: 30cm



LP8182-80 80kg

- » Diameter: 120cm
- » The inner diameter: 60cm
- » Height: 35cm

COVERED BATTLE ROPE

Swing Rope is a simple tool that almost anyone can use for a full body dynamic workout.

ITEM LP8172

- Heat-shrinkable non-slip handle
- High-strength polyester silk synthesis
- Cloth cover wrapping



Item	Size	Weight
LP8172-S1	1.5"x30'	7.6kg
LP8172-M1	1.5"x40'	10.2kg
LP8172-L1	1.5"x50'	12.8kg
LP8172-S2	2"x30'	13kg
LP8172-M2	2"x40'	17.4kg
LP8172-L2	2"x50'	21.8kg

BATTLE ROPE

- Heat-shrinkable non-slip handle
- High-strength polyester silk synthesis

ITEM LP8170



Item	Size	Weight
LP8170-S1	1.5"x30'	7.6kg
LP8170-M1	1.5"x40'	10.2kg
LP8170-L1	1.5"x50'	12.8kg
LP8170-S2	2"x30'	13kg
LP8170-M2	2"x40'	17.4kg
LP8170-L2	2"x50'	21.8kg

ALUMINUM HANDLE BATTLE ROPE

- Knurled aluminum handles
- High-strength polyester silk synthesis
- Rope diameter: 1.5"
- Handle diameter: 2"

ITEM LP8173



Item	Size	Weight
LP8173-S1	30'	8.1kg
LP8173-M1	40'	10.7kg
LP8173-L1	50'	13.3kg



SUSPENSION TRAINER



ITEM LP8162

This suspension trainer can improve core stability, is small, flexible, and can enhance your flexibility to exercise. It is also easy to carry and install anytime and anywhere. The kit includes hanging straps, door buckles, hanging buckles, and net bags. The length of the blue adjustment belt on the suspension can be freely adjusted. Training with the suspension trainer does not only exercise your whole body but also increases your body's stability.

- High quality, high-density polypropylene material
- Adjust the length as you like
- Alloy carabiner
- Integrated handle and foot
- Encrypted stepping on the line
- Adjustable length range180-270cm
- Webbing width: 3.8cm



AB MAT

ITEM LP8345

The AB mat is a tool to support your back while you are exercising your abs, ergonomically designed to bend your spine to lengthen your abdominal muscles and provide optimal comfort and range of motion while you are exercising.

- Waterproof and wear-resistant
- High-density EPE foam core
- Weight: 750g



GLUTE HAM ROLLER

ITEM LP8347

Designed specifically to be the best hamstring curl unit possible, we quickly found that it was great for a variety of ab, shoulder, leg and chest exercises as well. The Glute Ham Roller allows you to add or subtract resistance easily and is perfect for large groups, tight budgets, and mobile training needs.

- Size: 68x41x12.5(cm)
- Weight: 9kg



ELASTIC SUSPENSION TRAINER

ITEM LP8166

This suspension trainer has an extremely load bearing capacity and can be adjusted according to the changing goals of different body types. It is also a common training equipment for teams in modern gyms and boutique studios. The equipment is easy to install and can be easily done where there are poles or doors. This trainer exercises all of the body muscles while improving core strength, endurance, flexibility, and stability. It is very suitable for yoga, pilates, swimming, football, and basketball players.

- High-quality nylon webbing
- Alloy carabiner
- Comfortable non-slip handle
- Generous load-bearing band
- Multifunctional training
- Size: Latex tube: 500x14mm Weaving bandwidth: 3.8cm



WOODEN GYM RING

ITEM LP8123

Wooden gym rings are designed for fitness training, which is more challenging than pull-ups. This ring is built from 32mm diameter birch wood and is mainly used in strength training. The wood material is strong, durable, light weight, easy to carry and can be assembled quickly.

- Natural birch wood
- Iron locking buckle
- Anti-slip handle
- Ring diameter:32mm
- Outer diameter of ring:23.4cm



AB WHEEL

ITEM LP8346

Flexibility and versatility are the keys to any successful exercise program, this abs wheel can provide! Various postures and movements allow you to focus on various areas so that you can continuously exercise all major muscle groups.

- Unique design allows you to stretch and strengthen all four abdominal muscles
- Provides a smooth range of motion in any direction
- Made of engineering plastic, hard and durable



PUSH-UP BAR

ITEM LP8160

LIVEPRO push-up rack is different from those small push-up rack on the market in terms of size increased a lot with the height of 36.5cm and 63cm long, increasing the exercise space, so that training can be more easily. Its design also includes a convenient loading and unloading rubber feet, which not only plays a non-slip role, but also has more effective protection of the floor. Steel tube material and a wider base can withstand the extra weight, which is very stable. Training with this push-up brace will open up your pecs completely.

- High-quality steel material
- Anti-slip support feet
- Surface spraying
- Wider base



TACTICAL VEST

ITEM LP8194

Made of super durable nylon, the Tactical Vest is uniquely designed to provide the wearers with a greater range of motion with a lightweight feel and better ventilation. Unlike some similarly configured vests on the market, it can accommodate steel plates without causing volume restrictions. The shoulder foam padding reduces friction, and the adjustable tension straps improve stability for overall comfort.

- Durable weighted plates
- High-quality nylon fabric
- Lightweight waistband
- Comfortable shoulder design

- Includes:
 - 1 x 10kg size vest
 - 1 x Removable waist harness
 - 2x 5kg weight plate
 - Material: Nylon, foam, steel
 - Size: 53x32cm

PLATE



PARALLETES PAIR

ITEM LP8161

Livepro double bar is made of sturdy steel pipe with a thickness of 1.5mm and a maximum load capacity of 150kg, which is very strong and durable. A pair of practical rubber support feet, not only has a non-slip and stable role, but also can effectively protect the floor. With comfortable grip, athletes can grip tightly, which is not easy to take off, and increases the safety of sports. The double bar supports a variety of sports, regulates muscle groups, improves endurance, and is suitable for training in various scenarios such as home/gym/outdoor.

- High-quality steel pipe
- Anti-slip feet pad
- Thickened foam polyethylene material
- Bearing weight: 150kg



WEIGHTED VEST

ITEM LP8195

The design width of this weighted vest at the shoulder is 8cm, which increases the force surface of the shoulder and reduces the feeling of tightening on the shoulder during training. There are 5 weighted holes in the front and back of the vest. The weighted bags can be placed evenly in the front and back sandbags to achieve the purpose of weighted training. The resistance can be gradually increased by increasing the weight. The waist is fastened with a Velcro loop.

- High-quality Dupont material
- Weighted package padding can be adjusted
- Sponge sandwich with 2cm thickness
- Loop fastening belt
- Fixed by Velcro

10KG WEIGHTED VEST



20KG WEIGHTED VEST

Desc.	Includes
10KG WEIGHTED VEST	1x10kg size vest 1xremovable waist harness 10x1kg sand bag
20KG WEIGHTED VEST	1x20kg size vest 1xremovable waist harness 20x1kg sand bag



3-IN-1 WOOD PLYO BOX

ITEM LP8157

The 3-IN-1 wood plyo box is made of high-quality birch wood with a beautiful, non-slip, and special texture. The sturdy plywood and internal reinforcement components make the plyo box more stable and durable.

- Inner handle design
- High-quality birch material
- Surface non-slip texture
- Three different heights for various training techniques
- Cross-supported inside

- 3 heights selection
- Weight:23kg
- Size:50L×60W×75H(cm)
- Thickness:1.8cm



3-IN-1 SOFT PLYO BOX

ITEM LP8155

3-IN-1 soft plyo box can be used for a variety of exercises. The box can be flipped to obtain three different heights of 50/60/75cm for training. It has an inner wooden material, an outer non-slip leather wrap, and a center filled with EVA material. The plyo box is stable and extremely cushioned, thus better protecting the trainer and reduces leg injuries while jumping.

- Soft surface material
- Thick birch material
- High quality PVC material
- Three heights for various training
- Supported at right angles to ensure super load-bearing ability



STACKABLE RECTANGULAR PLYO BOX SET

ITEM LP8151

This plyo box for jumping is the perfect equipment to enhance one's explosive power. Five soft boxes of different heights can be combined and used in any combination or individually. They are excellently designed with bright colors to enhance one's training motivation. The inner portions are filled with pearl cotton, the surfaces are wrapped in PVC material, and strong velcro is used to ensure staking stability.

- Soft surface material
- Velcro is easy to operate
- Non-slip PVC surface
- 5 height options

Item	Size
LP8151-XS	900×750×75mm
LP8151-S	900×750×150mm
LP8151-M	900×750×300mm
LP8151-L	900×750×450mm
LP8151-XL	900×750×600mm



EPE



PRO STACKABLE RECTANGULAR PLYO BOX SET

ITEM LP8158

The plyo box horse is the perfect piece of equipment to enhance your explosive power. 4 soft boxes of different heights can be used in any combination stacked together or individually. The internal wooden frame construction provides excellent stability. The outer frame is wrapped in EVA for good cushioning and the outermost layer is wrapped in high quality PVC for a less rigid feel and to ease the impact on the legs and other parts of the body during training.

- High quality EVA
- Stability and safety
- Multiple training heights

- Weight: 15.5/22/32/36.5kg
- Dimensions: 90 x 75 x 15/30/45/60cm



SUPER BAND

ITEM LP8410



Livepro Super Bands are thick and designed specifically for weight training and are very effective for both upper and lower body training for a variety of strength, speed, flexibility and rehabilitation exercises. Super Bands are great for assisting with pull-ups, sit-ups, and improving lateral and forward speed with exercises such as jogging, behind-the-back drags, and lunges.

- Made of 100% natural latex
- Multifunctional training tools
- 5 different kinds of resistance

Item	Color	Size	Strength
LP8410-XL	Purple	2080x13x4.5mm	15-35LBS
LP8410-L	Green	2080x22x4.5mm	25-65LBS
LP8410-M	Blue	2080x32x4.5mm	35-85LBS
LP8410-H	Red	2080x45x4.5mm	50-125LBS
LP8410-XH	Black	2080x64x4.5mm	65-170LBS



RESISTANCE TUBE

ITEM LP8401

Livepro latex cloth sleeve resistance tube is suitable for fixed use at home, office and gym for full body exercise, which is a very effective training tool to enhance core strength, cardiovascular endurance and coordination. Internal high-quality latex tube, has high elasticity, high tensile strength, good rebound, and is not easy to deformation. Polyester fabric cover is wrapped externally, which is high strength, wear-resistant and anti-pull. Strong and durable aluminum climbing buckle is for connection and fixation, which is very durable. Set contains four resistance values (10/20/30/40LBS), with a variety of combinations to meet different training needs.

- High-quality latex inner tube
- High-strength polyester fabric cover
- Aluminum climbing buckle



Item	Color	Size
LP8401-L	Yellow	L(10LBS)
LP8401-M	Green	M(20LBS)
LP8401-H	Red	H(30LBS)
LP8401-XH	Blue	XH(40LBS)

FOOT STRAP

ITEM LP8404

- Soft EVA underlayer
- Durable polyester tape
- Metal steel buckle
- Adjustable until fit to all users



HANDLE

ITEM LP8406

- High quality TPR material
- Wider and more comfortable handle
- Prismatic texture is designed on the handle



POWER PULL BELT

ITEM LP8094

- Outer PU leather
- One size fits many body types
- Ergonomic design



LIVEPRO RESISTANCE BAR

ITEM LP8400



Livepro Resistance Bar is a resistance workout gear used with resistance rope, which can be used for biceps and triceps exercise, standing bench press, push-ups. Both sides are disposed with steel hanging holes, one end is securely welded, the other end can rotate 360° smoothly, so that rope winding can be avoided. The inner core is made of high-grade steel, and the surface is applied with black glossy painting, which is durable, sturdy and resistant to rust. Two sections of high-density foam grips are disposed externally of steel pipes, which provide comfortable grip and safer workout.

- Made of sturdy and durable, high-grade steel material
- Movable hanging hole
- Designed with two-section threaded bar





LOOP BANDS

Loop bands are made from natural latex and have four different resistance levels. **ITEM LP8412**
 Loop bands are great for both upper and lower body exercise and are suitable for side-stepping, leg stretching and shoulder stability training. They are also ideal for rehabilitation and strength training. The loop band is very durable and can be stretched up to 3 times its length, making it easy to carry and can be used anywhere.

- 100% natural latex
- Multifunctional training tools
- Resistance: 10/20/30/40lb



Item	Color	Size	Strength
LP8412-L	Green	500x50x0.4mm	10LBS
LP8412-M	Blue	500x50x0.7mm	20LBS
LP8412-H	Red	500x50x0.9mm	30LBS
LP8412-XH	Black	500x50x1.2mm	40LBS

FABRIC LOOP BAND

Fabric loop bands are very effective for both upper and lower body training, perfect for lateral footwork, leg extensions and shoulder stabilization exercises, and ideal for rehabilitation and strength training. The magic circles are durable and can be stretched up to three times their length, making them easy to carry and suitable for use anywhere. **ITEM LP8414**

- High-quality cotton material
- Multifunctional training tools
- 3 different types of resistance
- Compact and lightweight



Item	Color	Size	Strength
LP8414-L	Black	58x6cm	120-250LBS
LP8414-M	Blue	63x7cm	120-250LBS
LP8414-H	Red	68x8cm	120-250LBS

RESISTANCE BAND

The resistance band is a versatile piece of equipment that is ideal for rehabilitation, Pilates training and daily gymnastics, and can be used to exercise virtually every muscle and joint, building endurance and strength. **ITEM LP8413**

- High-quality TPE material
- Multifunctional training tools
- Resistance: 5/10/15/20/25lb
- Compact and lightweight



Item	Color	Size	Strength
LP8413-XL	Green	2000x150x0.3mm	5LBS
LP8413-L	Yellow	2000x150x0.4mm	10LBS
LP8413-M	Red	2000x150x0.5mm	15LBS
LP8413-H	Blue	2000x150x0.6mm	20LBS
LP8413-XH	Black	2000x150x0.7mm	25LBS

RESISTANCE TUBE

Resistance tube is made of latex elastic material has non-slip, textured handles at both ends. Yellow, blue, red and gray pipes are available, each with a length of 120cm, and the resistance force gradually increases with the stretching. The resistance tube is lightweight and portable, so you can exercise with it from place to place. **ITEM LP8405**

- High-grade latex material
- Cladded with a ring of TPR material
- Non-slip design
- Coupling design



Item	Color	Size	Strength
LP8405-L	Yellow	6x10x1200mm	L
LP8405-M	Blue	7x11x1200mm	M
LP8405-H	Red	5x11x1200mm	H
LP8405-XH	Gray	6x13x1200mm	XH



PULL-UP ASSISTED BAND

Easier to adjust the length and fixation, this pull-up band can also be easily installed and removed. The three inserted resistance elastic bands can be installed in less than 30 seconds, combining variable resistance bodyweight training with instability, and the non-slip foot stirrups can be used as a assisted band for pull-up training. **ITEM LP8428**

- Easier to adjust the length and fix
- High-quality latex material
- Nylon fabric cover protected
- Foam handle increases grip
- Elastic band has tension of 30LB, whose stretchable length can be three times of the original length, and can be stretched more than 10,000 times



DOUBLE RESISTANCE TRAINER

After putting the equipment on, come to a resistance training, experience the whole-body resistance and impact brought by the equipment. Our products are thoroughly tested to exercise your whole body, and you can get a stronger core strength with the fight training. **ITEM LP8424**

- High-quality latex material
- Nylon fabric cover protected
- Easy to install, disassemble and adjust
- Elastic band has tension of 30LB, whose stretchable length can be three times of the original length, and can be stretched more than 10,000 times

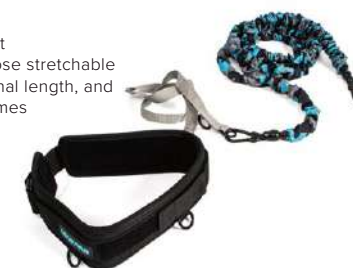

STRETCH TRAINER

It trains your entire body with a combination of variable resistance bodyweight training and instability, builds core strength, shapes your legs, hips and you can get a stronger core to support your whole body. **ITEM LP8427**

- High-quality latex material
- Nylon fabric cover protected
- Easy to install, disassemble and adjust
- Stretched more than 10,000 times



EXPLOSIVE POWER TRAINER

This product plays a very active role in strength training, combining variable resistance bodyweight training with instability through a quality resistance band. It meets a variety of athletic goals, shapes your core, exercises your legs, hips, and arms, and you can get a stronger core to support your entire body. **ITEM LP8425**

- Easy to install, disassemble and adjust
- Stretched more than 10,000 times
- High-quality latex material
- Nylon fabric cover protected



DOUBLE COMBAT TRAINER

It builds strength and endurance through training and lends two sets of rings to add resistance to each movement such as striking, connecting the four resistance bands of the wrist strap and foot sleeve to a fixed point, and then you start practicing. **ITEM LP8426**

- High-quality latex material
- Nylon fabric cover protected
- Easy to install, disassemble and adjust
- Stretched more than 10,000 times



CHEST EXPANDER

This chest developer can be adjusted by the number of resistance tube to choose the appropriate resistance and provide progressive resistance in the traditional exercise, thereby enhancing the chest, shoulders, arms and front core strength. It is wrapped by nylon material externally, which increases the feel of the hand and also plays a role in protecting athletes and latex tube. **ITEM LP8430**

- Adjustable resistance
- High-quality latex material
- Waist support with multiple sports
- Foam grip
- Stretched more than 10,000 times

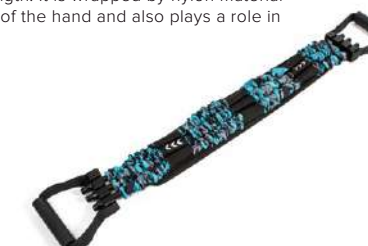

BOUNCE TRAINER

Bounce trainer is perfect for basketball, volleyball, soccer, tennis, running and other training, exercises the hip, calf, abdomen or limb strength, increases vertical jump, improves leg strength, explosive power, flexibility, balance and endurance. **ITEM LP8429**

- High-quality latex material
- Nylon fabric cover protected
- Easy to install, disassemble and adjust
- Stretched more than 10,000 times





FUNCTIONAL

SPEED CHUTE

- Providing resistance to build total body speed & power.
- Developing rapid acceleration and proper form.
- Quick releasing buckle allows mid-run over-speed surge

ITEM LP8613

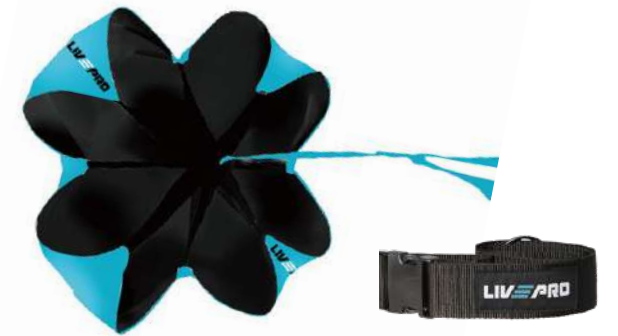

QUICK HURDLES

Adjustable hurdles can train an athlete's reaction and improve agility by stepping and jumping exercises. Livepro's hurdles are made of light PP material that is portable and can be used anywhere at any time.

- High quality engineering plastic material
- Height adjustable
- Lightweight and easy to carry
- covered with soft blue plastic to effectively protect the product,



ITEM LP8615

QUICK CONES

With these durable cone-shaped marker discs, athletes can train their reaction and agility ability. They can train accelerating, decelerating, and lateral moving footwork. The height of the discs are 6.5cm and the bright colors ensure that they are visible. The logo discs are made of soft and high strength plastic that will not break when stepped on and can be used for a long time.

- High strength plastic material
- Lightweight and easy to carry
- Bright colors



ITEM LP8616

AGILITY CONE

The agility cone is a key equipment to train agility and speed. With good equipment, comes more effective training. The Livepro agility cone is made out of soft, high strength, and durable materials. These materials will not break even when stepped on and do not cause damage to athletes.

- High strength plastic material
- Lightweight and easy to carry
- Better balance and stability.
- Diversified training methods



ITEM LP8618

HURDLE POLE

Create dynamic and challenging speed and agility training sessions to quickly improve your footwork and agility.

- Great for Speed & Agility
- Fits all Notched Soccer Cones

- **Diameter: 2.5cm**
- **Length: 100cm**



ITEM LP8617

AGILITY DOT

Livepro's agility marking disc has a diameter of 20cm and a thickness of 2.5mm. It can be set in a variety of ways for use in footwork, agility, and reaction ability training. Livepro's agile marking discs are made of polyurethane material that has a strong corrosion resistance and wear resistance. They can be used repeatedly without being deformed.

- High quality polyurethane material
- Reverse non-slip design
- Digital sign



ITEM LP8610

AGILITY GRID SYSTEM

Livepros Hexagonal Agile Ladder can exercise agility and speed. It is a durable frame that can be freely combined to achieve various layouts and add vitality to exercises. The ladders frame has a thickness of 11mm and is made of high strength engineering plastic. It is wear resistant. Will not easily deform, and will not break even when stepped on. It can be used for long periods of time indoors and outdoors.

- High quality engineering plastic material
- Lightweight and easy to carry
- Use the black buckles to form any combination



ITEM LP8612



LATERAL ENDURANCE HURDLE

The outer layer of the soft hurdles are made of PVC leather and the inside is made of EPE material. The EPE material is very soft and suitable for high-intensity speed and agility training. Its surface layer is waterproof and easy to clean. The base has a length of 60cm and a width of 20cm to provide excellent stability during training.

- High quality PVC and EPE materials
- Interior EPE is highly elastic
- Better balance and stability.



ITEM LP8611

HURDLES SET

- Easy to disassemble
- The rod is fully adjustable up to 150 cm
- Suitable for indoor and outdoor and competitive sports

- **Diameter: 2.5cm**
- **Length: 150cm**



ITEM LP8619

www.livepro-fitness.com

SPEED BAG

The speed bag is used for speed and explosive training, with 4 booster bags full of sand and a maximum weight of 20kg, with adjustable length webbing to increase explosive power through forward, backward and lateral training. Speed bag outside is wear-resistant rubber material, can be used indoors and outdoors, will not damage the floor and will not easily wear. Inside PVC leather is waterproof and wear-resistant, and easy to clean.

- Wear-resistant rubber on the outside
- Internal PVC leather
- Strong and adjustable nylon webbing
- Good resistance to stretching capacity.

ITEM LP8184



RUBBER AGILITY LADDER

Livepro's agility ladder is made of high quality durable rubber material. The material is not easily worn out. This ladder can be used for agility, flexibility, and balance training. The agility ladder has high toughness and great stability.

- High quality rubber material
- High toughness, stability, and not easily tangled
- Grids with numbers 1-10 designed
- Easy to store
- Length:452cm
- Width: 41cm

ITEM LP8621



www.livepro-fitness.com



SLED

Resistance sled is a sled-like training tool that can be stacked with heavy weights (usually barbell weight plates), in order to increase physical fitness and speed during exercise, and can mobilize almost the whole body muscle groups during training, with great exertion and simple movements, making it a priority for strength training. The sled is made of durable steel tubing, with very little welded construction, very strong and durable. It can also be pushed and pulled on multiple surfaces with accessories and has a flat bottom, allowing training on a variety of surfaces.

- High-quality steel pipe, not easy to rust after high temperature baking
- Explosive power and strength of the movement
- A variety of sports
- Smooth base
- Size: 110x67x(70-107)cm



Harness vest

ITEM LP8146



ITEM LP8142

LIVEPRO SLED

The sled transportation method is in line with the functional training that is now advocated. Using sled training can help you exercise your body muscles, improve athletic ability, and reduce fat. There are many exercise methods for sledding, such as pushing sled, pulling sled, crawling, sledding and so on.

- The flat bottom and strong steel plate allow you to push and pull smoothly on multiple surfaces
- Can be used with any standard aperture plates
- Made of steel, strong and durable
- Provides 6 kinds of attachments, which can transform the sled into a "lawn mower", "wheelbarrow" or skateboard within a few minutes, which can be pulled by the attached safety belt and brought to the carabiner attachment.



GYM SLED

Ideal for strength and functional training, this newly designed sled is the most versatile sled on the market. The thickness of the base steel plate is 5mm, which is wear-resistant and can be used for any ground from asphalt to turf. Two detachable push-pull rods for easy change of direction. It is also equipped with a handle with a length of 107cm, which is suitable for sports such as pushing and pulling. The solid steel half of the bottom bracket can be used for training with the drawstring to achieve diversified training.

- High quality materials
- A variety of sports
- Smooth base

- Size: 150x57x77cm
- Weight: 40kg



ITEM LP8148

LANDMINE HOME BASE

- High-quality steel material
- Powder coating is not easy to corrosion and rust
- 9.9mm thickened steel base
- Rotate and swing on multiple axes

- Size: 45x45cm
- Weight: 18kg
- Barrel diameter: 52mm



ITEM LP8185

T-BAR HANDLE

ITEM LP8186



SINGLE HANDLE

ITEM LP8187



MEDICINE BALL REBOUNDER

Durable medicine ball rebounder is made of steel, with 10 adjustable height, each adjustable angle of 6 ° and different angles for different effects of exercise. The side of the trampoline is raised or lowered to form a certain angle with the ground, and the rebounder can be used for training related to medicine ball, which can exercise the core, balance and explosive power. The rebound surface is made of high-quality elastic cloth plus Oxford cloth, and the perimeter is fixed by steel springs, which are elastic enough, strong and durable. Widened and thickened foot pads is more smooth in the training process.

- 10-gear heights and each adjustment angle of 6 °
- High-quality Oxford cloth and elastic cloth
- High-quality spring steel
- Exercise explosive power and core strength

- Base: 1069x984x104mm
- Border bottom pipe mouth: 25x50mm
- Jump bed: 902x902mm, 32 waist drum spring



ITEM LP8255

MULTI-USE HANGER

Multi-use hangers are gym-ready accessories for storing belts, jump ropes, elastic bands and more. Although it is a simple accessory. It not only helps to clean up the training space, but also can effectively improve the efficiency of exercise and help athletes find the required equipment quickly and easily.

- 6mm thick high quality Q195 steel
- Black plastic powder coated
- Screw reinforces stability
- Size: 60Lx 12.5Wx16.9H(cm)



ITEM LP8817

SUSPENSION TRAINING RACK



ITEM LP8870

Item	Person	Size	Weight
LP8870-06	06	323x256x269cm	180kg
LP8870-12	12	625x262x273cm	295kg
LP8870-18	18	930x267x278cm	445kg

INTERVAL TIMER

- 4 inches width, a total of , mode, hours, minutes display
- Equipped with charger, remote control, voltage 220V
- The 4.0" LED digits in blue/red are visible from hundreds of feet away
- Great for hiit, mma, boxing, fitness bootcamps, and other interval
- Training regimens
- Integrate heart rate monitoring into your workouts and have your heart rate periodically or permanently display on the clock so you know how hard you're working and can set a proper pace
- Size: 72x16x4cm



ITEM LP8143

MULTI-ROPE HOLDER

The Multi-Rope Holder can hold up to 10 training ropes or battling ropes so multiple people can work out in one dedicated space. With the Multi-Rope Holder, there is no need to attach your Training Ropes or Battling Ropes to a wall. Just add weight plates to the center post, attach your Training Ropes and begin working out.

- Material: Steel
- Height: 60cm
- Base diameter: 50cm



ITEM LP8174

BATTLE ROPE STORAGE HANGER

- Size: 34.3x20x5cm

ITEM LP8178



BATTLE ROPE ANCHOR

- Size: 23x5x9cm

ITEM LP8179





3 TIER KETTLEBELL RACK

ITEM LP8805

With metal frame and black matte surface, it looks textured and couples aesthetic design with high-grade material. The anti-falling design on edges appears to be aesthetic and impressive.

- Size: 106.5L×64.5W×82H(cm)
- Size: 37kg
- Assembly required
- Balls NOT included



2 TIER KETTLEBELL RACK

ITEM LP8905

The kettlebell frame is made of Q195 steel, strong and stable. When picking or placing the kettlebell, a stable non-slip tray can fix the kettlebell in place to prevent it from falling. It can ensure that you can quickly store various dumbbells and kettlebells after strength training for convenient storage.

- Size: 151L×84W×81H(cm)
- Assembly required



3 TIER STORAGE RACK

ITEM LP8906

The metal frame and black matte finish are textured. It combines an aesthetically pleasing design with premium materials. The anti-drop design of the edge makes the overall beautiful and elegant. Wide support feet provide extra stability, and rubber feet on the bottom protect the floor from scratches.

- Size: 204L×84W×81H(cm)
- Assembly required



POWER BARBELL RACK

ITEM LP8871

Made of pure steel, it is stylish, beautiful and sturdy. With vertical storage, it is more space-saving. It is stored safely, which is easy to pick up. The middle 3 segments of the round tube are separated into 4 segments of space and placed separately, and the two bases add rubber gaskets respectively to effectively protect the ground and surrounding products.

- Color: Black
- Size: 89L×61W×110H(cm)
- Weight: 20.5kg
- Assembly required
- Balls NOT included



STORAGE RACK

ITEM LP8875

It is made of sturdy steel for inherent strength, and the black powder-coated finish adds feel and corrosion resistance. The storage rack is innovative and practical, providing a one-stop storage solution for a variety of functional training equipment on a daily basis.

- Color: Black
- Size: 55L×60W×180H(cm)
- Weight: 68kg
- Assembly required
- Balls NOT included



STORAGE RACK

ITEM LP8897

This is a versatile storage shelf that keeps your equipment neat and in tip-top shape when it is not in use. It is Made of sturdy steel for inherent strength. The black frosting sprayed adds feel and corrosion resistance. It is powerful enough to store 6 medicine balls, 3 yoga balls, hanging tools and foam shafts on the front and back.

- Size: 156.5L×76.6W×197.4H (cm)
- Weight: 73kg
- Assembly required
- Balls NOT included



5 MEDICINE BALL RACK

ITEM LP8865

The unique upturned head structure prevents the medicine ball from sliding and falling, and the thickened round tube design provides better load-bearing performance and overall visual effect is more aesthetically pleasing. Our single-sided ball rack has a widened base for extra stability and rubber feet is on the bottom to protect the floor from scratches.

- Size: 48.5L×36W×157.5H(cm)
- Weight: 20.5kg
- Assembly required



10 MEDICINE BALL RACK

ITEM LP8806

The double-sided medicine ball rack provides a vertical storage solution for up to 10 medicine balls, reducing wasted gym space. With an improved design, it holds balls on both sides, making it easy for trainers to access, in addition to increasing the number of balls stored.

- Wide A-shaped base is for extra stability
- Double-sided storage
- Seamless welding technology
- Color: black

- Size: 37L×56W×141H(cm)
- Weight: 11.5kg
- Assembly required
- Balls NOT included



WALL BALL RACK

ITEM LP8811

This single-sided rack holds up to 5 wall balls and features a highly durable frame structure with a unique internal support design that prevents the energy pack from sagging in the middle and helps maintain its shape, making it an ideal storage solution for the gym.

- seamless welding technology
- Wider base is more stable
- Prevent the sphere from sagging
- Increase space utilization

- Size: 66L×76W×173H(cm)
- Weight: 21.7kg
- Assembly required
- Balls NOT included



POWER BAG RACK

ITEM LP8802

The power bag rack holds up to 5 energy packs and features a highly durable frame structure with a unique internal support design that prevents the pack from sagging in the middle and helps maintain its shape, making it an ideal storage solution for the gym.

- Seamless welding technology
- Wider base is more stable
- Increase space utilization

- Size: 66L×76W×145.5H(cm)
- Weight: 20.5kg
- Assembly required
- Balls NOT included



BRACKETS-MEDBALL STORAGE

ITEM LP8892

6mm thick wall main plate, with 2.5mm thick, 25mm diameter wall ball support round tube, has better load-bearing performance and metal matte surface looks very textured for an overall aesthetically pleasing look. The main plate is fixed to the wall by 6 screws, which is stable and durable.

- Size: 125L×37.5W×97.3H(cm)
- Weight: 48kg
- Assembly required
- Balls NOT included



STORAGE BOX

ITEM LP8862

The flip lid is made of 4mm diameter steel wire edge with shock absorbing material to make it more silent. With 130cm long, 70cm wide and 81cm deep, it has a large enough storage space to accommodate such as resistance tubes, boxing gloves, gym balls, etc. The four corners assembled with universal wheels, can easily move and is very convenient.

- Size: 130L×70W×81H(cm)
- Weight: 43kg
- Assembly required



02

NEW FOR 2022

GROUP TRAINING

www.livepro-fitness.com

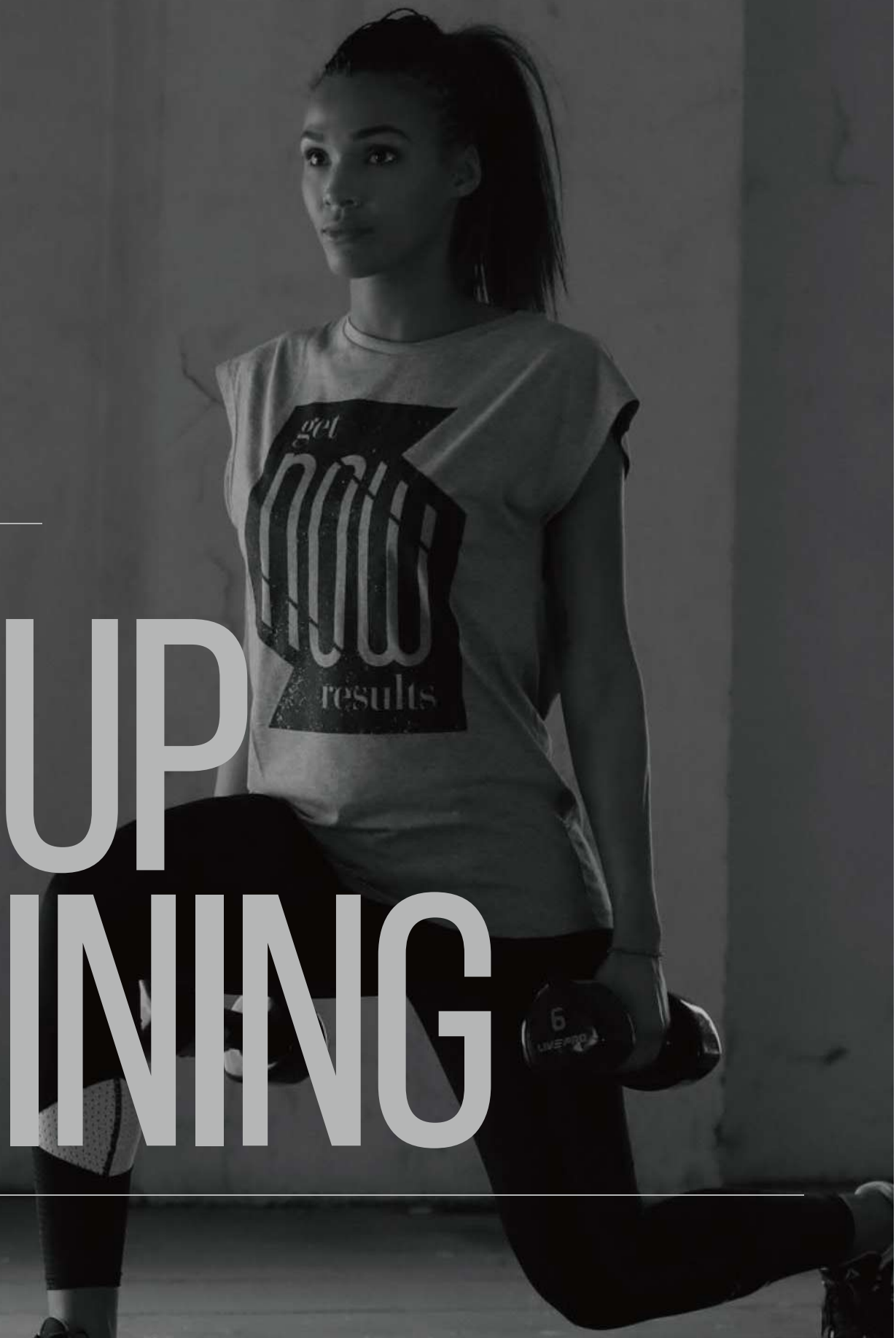

GROUP TRAINING

URETHANE BARBELL SET

The urethane barbell set is made of urethane. It is composed of high-strength and extremely durable bell plates, which are resistant to aging and wear. This set contains a pair of 5kg, 2.5kg, and 1.25kg plates.

- High quality polyurethane
- Vibrant color scheme
- Non-slip grip
- Quick installation of the chuck



ITEM LP8030

Desc	Item	Weight	Plate	Bar&Collar
Studio Urethane Barbell Set	LP8030-A	20kg	2x5kg, 2x2.5kg, 2x1.25kg	Pattern Printing Bar
	LP8030-B	20kg	2x5kg, 2x2.5kg, 2x1.25kg	Foam Cover Bar

RUBBER BARBELL SET

Livepro rubber barbell set is made of high-quality and durable rubber, which is a kind of high strength and durable weight plates with high elasticity and anti-drop. 20kg set includes a pair of 5kg weight plates, a pair of 2.5 kg weight plates and a pair of 1.25 kg weight plates; 40kg set includes a pair of 10kg weight plates, a pair of 5kg weight plates, a pair of 2.5 kg weight plates, and a pair of 1.25 kg weight plates. The vibrant color scheme helps to identify the weight quickly.

- High-quality rubber weight plates
- Vibrant color scheme
- Non-slip grip
- Quick installation of the chuck



ITEM LP8031

Desc	Item	Weight	Plate	Bar&Collar
Rubber Barbell Set	LP8031-20A	20kg	2x5kg, 2x2.5kg, 2x1.25kg	Pattern Printing Bar
	LP8031-20B	20kg	2x5kg, 2x2.5kg, 2x1.25kg	Foam Cover Bar
Rubber Barbell Set	LP8031-40A	40kg	2x10kg, 2x5kg, 2x2.5kg, 2x1.25kg	Pattern Printing Bar
	LP8031-40B	40kg	2x10kg, 2x5kg, 2x2.5kg, 2x1.25kg	Foam Cover Bar

PREMIUM URETHANE BARBELL SET

Livepro studio chromed barbell set is made of high-quality and durable polyurethane material, which is a kind of high strength and durable weight plates with high elasticity and anti-drop. 20kg set includes a pair of 5kg weight plates, a pair of 2.5 kg weight plates and a pair of 1.25 kg weight plates; 20kg set includes a pair of 10kg weight plates, a pair of 5kg weight plates, a pair of 2.5 kg weight plates, and a pair of 1.25 kg weight plates.

- High-quality rubber weight plates
- Vibrant color scheme
- Non-slip grip
- Quick installation of the chuck



ITEM LP8032

Desc	Item	Plate	Weight	Bar&Collar
Premium Urethane Barbell Set	LP8032-20A	2x5kg, 2x2.5kg, 2x1.25kg	20kg	Pattern Printing Bar
	LP8032-20B	2x5kg, 2x2.5kg, 2x1.25kg	20kg	Foam Cover Bar
Premium Urethane Barbell Set	LP8032-40A	2x10kg, 2x5kg, 2x2.5kg, 2x1.25kg	40kg	Pattern Printing Bar
	LP8032-40B	2x10kg, 2x5kg, 2x2.5kg, 2x1.25kg	40kg	Foam Cover Bar

www.livepro-fitness.com



CLASSIC BARBELL SET

Livepro Classic Barbell Set is well-tailored for fitness studios, home fitness and gyms. The eye-catching color and appearance and octagonal design can prevent plates from rolling here and there. The set is offered in 20kg or 40kg weight based on your choice, the bar surface is subject to plating process, so it is smooth and of textural quality, sturdy, corrosion-resistant and protected against rust. The steel spring clip is secure, fastened and locked.

ITEM LP8035

- Enclosed by high-grade PE which features strong corrosion resistance and long service life
- Lively color scheme
- Plating finish of bars
- 1.5mm knurling design

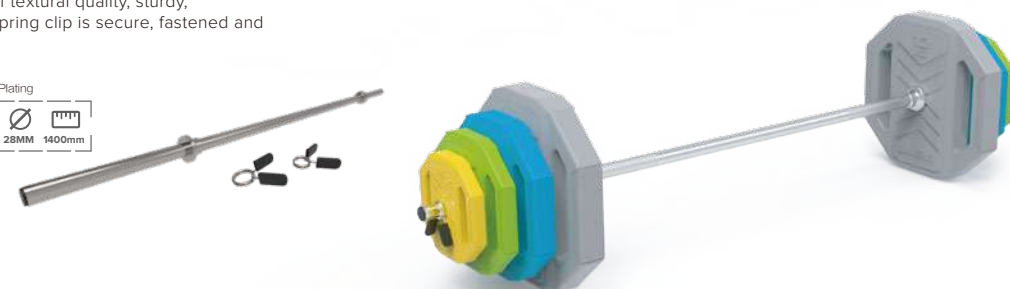

Desc	Item	Plate	Weight
CLASSIC BARBELL SET	LP8035-20	2x5kg, 2x2.5kg, 2x1.25kg	20kg
	LP8035-40	2x10kg, 2x5kg, 2x2.5kg, 2x1.25kg	40kg

LIVEPRO SMART PUMP SET

The LIVEPRO SMART PUMP SET has been re-engineered for new levels of performance. Its cutting edge technology allows for faster, smoother weight plate transitions with no need for clips to hold weights in place.

ITEM LP8036

- Clip-free for fast, smooth & easy weight changes
- Optimal bar diameter reduces hand and forearm fatigue
- Plates double as hand-weights
- Plates: Premium rubber surface coating
- Rotating ends aid muscle isolation and put less pressure on the wrists
- The advanced ergonomic design of the set improves exercise form, creating better results and making it a more enjoyable barbell to use.



Item	Weight	Plate	Bar Weight	Bar Dimensions
LP8034	19.5kg	2x1kg, 2x2.5kg, 2x5kg	2.5kg	1414x97x60mm

WEIGHT BAR

Stainless steel core wrapped with comfortable and high-quality foam made of weight bar, can carry out a series of strength training and flexibility exercise. The sturdy steel core has high toughness and durability and is not easily bent and broken after repeated use. It is wrapped with comfortable non-slip foam on the surface and suitable for a variety of sports, including lunges, squats, sit-ups and other exercises.

ITEM LP8145

- High-quality steel core
- The surface layer of high-quality foam wrapped
- TPR material on both sides
- Multiple colors to choose from

Item	Color	Length	Weight
LP8145-02	Orange	118.5cm	2kg
LP8145-03	Green	118.5cm	3kg
LP8145-04	Red	118.5cm	4kg
LP8145-05	Purple	118.5cm	5kg
LP8145-06	Blue	118.5cm	6kg



LIVEPRO STEP

It can be used for aerobic pedal gymnastics training, mainly for hamstring and hip muscles, with many variations of movements and more entertaining, so it is sought after by fitness people at home and abroad. The pedal pads can also be used as training equipment alone, in short, can provide a variety of training solutions, and is an indispensable training tool.

ITEM LP8244

- The surface bar is welded, which is not easy to loosen
- Tread texture design increases the grip
- TPE pad foot increases the stability
- Target training area on the surface is more humanized
- Adjustable height
- Safety locking
- Size: 108x43x(10.5-15.8)cm



Item	Color
LP8244-RD	Red
LP8244-BU	Blue

AEROBIC FITNESS STEP

Aerobic Fitness Step is a terrific fitness gear, which can exercise the body, improve the cardiovascular system, and also strengthen the muscles of the legs and upper body. The height of fitness step can be adjusted freely whenever necessary (15/20/25cm), and the broad anti-slip base and slide-proof feet make it firm during workout.

ITEM LP8240

- PP board as the main component is impact-resistant
- Have a strong coefficient
- 15/20/25cm three height adjustable
- Size: 96.5Lx37Wx15/20/25H(cm)



ANATOMIC HOT SPOTS
Precise targets as a guide for correct foot and hand positions, and to hit in combinations for endless variety and challenge.

HEAT WELDED TOP MATS
Instead of simply gluing the mats to the STEP and RISER they are attached via more robust heat welding for long-term performance.



LOCKING CONNECTORS
Line up the red connectors and a firm push locks STEPS and RISERS securely together.



MINI FITNESS STEP

The product is made of high-grade TPE with surface texture, which has a soft touch and guarantees firmness and stability. Step aerobics on the mini step can exercise the muscles of hamstrings and buttocks, supports a diversity of actions and provides better recreation.

ITEM LP8244-B

- A plurality of anti-slip mechanisms
- Target workout zone
- Special locking structure



Item	Color
LP8244-B-RD	Red
LP8244-B-BU	Blue



PRO-BOX 2.0

Designed for functional training, this all-in-one fitness bench is the latest idea in fitness bench solutions, perfectly designed to speed up transitions and improve safety, storing equipment neatly. It can make your training field look more neat and orderly and make training seamless, so this fitness bench will not only give you a different experience, but also accommodate what you need for your workout program.

ITEM LP8863-E

- High-quality steel tube material
- Multiple storage ports
- Multifunctional Training
- Hydraulic lever to adjust the angle of the backrest
- Wheels design, which is easy to move
- Size: 1396L×420W×513H(mm)
- Weight: 83kg
- Bearing: 300kg



MULTI-FUNCTION DECK

This multifunctional pedal brings more creative thinking to pedal training sessions. One pedal can be used for a variety of purposes, including pedal exercises, push-ups, dumbbell benches, and strength training with a tensioner. The folding foot can be used to increase or decrease the height of the pedal, adjusting the brace foot can change the different tilt angle, experience a different way of movement. Non-slip padded feet and non-slip surface can increase the stability of the pedal, so that the movement is safer and more professional.

- Anti-slip surface material plus texture design
- Rubber foot pad enhances the stability of the pedal
- Pedal backrest 3-gear adjustment
- Multifunctional storage space
- Size: 122L×33W×20-35.5H(cm)

ITEM LP8241

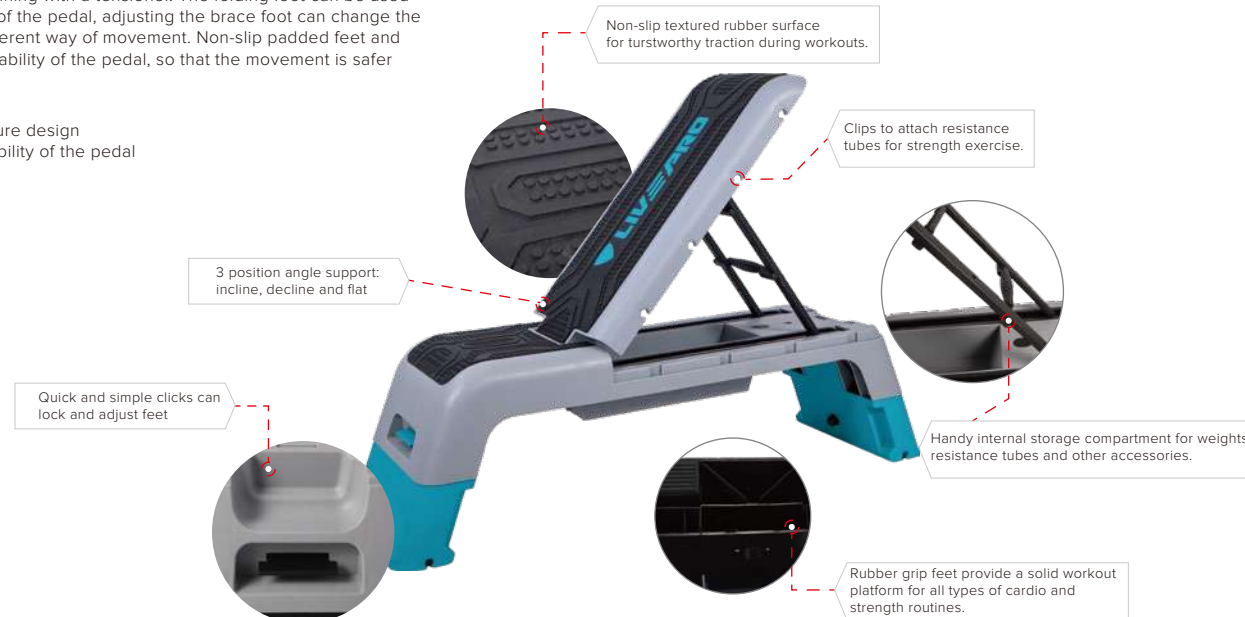

TRAMPOLINE

LIVEPRO trampoline has a sturdy steel structure and safe design and the whole frame and support legs are made of rust-proof and durable steel pipes. 6 legs are equipped with protective rubber support feet for effective anti-slip. High-stretch latex elastic band is tough and super load-bearing. High-quality polyester mesh fabric is strong and durable, and the whole frame can ensure balance and stability, making the movement safer.

ITEM LP8250

- 1.8mm thick steel tube is thick and durable
- High-quality bouncing surface
- The maximum load-bearing capacity is 150kg, and the number of bounces is tested to be over 50,000 times
- Round tube diameter:28mm
- Support foot diameter:25mm
- Tube thickness:1.8mm
- Plane width:100cm
- Bounce surface width:75cm
- Support foot height:20cm



PRO TRAMPOLINE WITH HANDLE

LIVEPRO Armrest Trampoline has solid steel structure and safe design, the whole frame and feet are made of rust-proof and durable steel pipes. The hexagonal, ultra-wide bouncing surface trampoline and the height-adjustable armrest design make it easy for gripping during workout, so the safety level can be improved.

ITEM LP8251

- 2.5mm thick steel pipes are thick and durable
- High-grade bouncing surface
- With the maximum load capacity is 150kg, it can withstand over 50,000 bounce cycles in test
- Anti-rust coating of steel pipes
- Adjustable armrest
- Diameter of bottom round tube:32mm
- Tube thickness:2.5mm
- Plane width:135cm
- Bounce surface width:105cm
- Support foot height:35cm



FITNESS SLACKRACK

It can be used for balance training and resistance training. It can be used along with other equipment to complete some movements and achieve whole body training. The equipment has a power coated metal frame, a 5m long classic webbing rope, and can be easily installed in 15 minutes. One end rotates to complete the length and tightness of the webbing.

- High quality Q235 tubes
- High temperatures to increase the feel, texture, and corrosion
- Manually adjust the length and tightness
- PVC leather wrap on both sides
- Anti-slip rubber pad

- Material: Steel
- Weight: 23kg
- Size: 205.5×34×32cm
- Width of webbing: 5cm



ITEM LP8217



SPRING TRAMPOLINE

The LIVEPRO spring trampoline has a sturdy steel construction and safer design. The entire frame and support legs are made of rustproof and durable steel tubing. All 6 legs have protective rubber sleeve support legs for effective anti-slip. 36 steel wire springs for extra load-bearing, strong and more durable. High quality polyester mesh for strength and durability. The entire frame ensures balance and stability for safer movement.

ITEM LP8253

- High quality materials
- Reinforced drum springs
- Velcro protected springs
- The bouncing surface is made of high quality polyester mesh
- Anti-slip foot cover
- Safety cover
- Maximum load capacity of 150kg
- Support foot height: 17cm
- Trampoline diameter: 101cm
- Support foot diameter: 25mm
- Number of springs: 36



TRAMPOLINE WITH HANDLE

LIVEPRO trampoline with handle has a sturdy steel structure and safe design, the whole frame and support feet are made of rust-proof and durable steel tubes, and the handle is added to the original trampoline to facilitate the grip and improve safety when you are exercising.

ITEM LP8250B

- 1.8mm thick steel tube is thick and durable
- High-quality bouncing surface
- The maximum load-bearing capacity is 150kg, and the number of bounces is tested to be over 50,000 times
- Steel tube anti-rust spraying
- Diameter of bottom round tube: 28mm
- Support foot diameter: 25mm
- Tube thickness: 1.8mm
- Plane width: 100cm
- Bounce surface width: 75cm
- Support foot height: 20cm





SMART PUMPSET RACK

Clean and sophisticated style to house 14 sets of insert barbell sets, including bells and poles.

ITEM LP8873

- Size: 120Lx23Wx137H(cm)
- Weight: 54kg
- Assembly required
- Balls NOT included



10 PUMPSET RACK

- Black powder paint spraying
- The widened base provides extra stability
- The widened storage rack can accommodate 10 sets of LESMILLS barbells
- Equipped with friction-resistant washer

ITEM LP8801

- Size: 80Lx53Wx142H(cm)
- Weight: 25.5kg
- Assembly required



20 PUMPSET RACK

- Black powder paint spraying
- The widened base provides extra stability
- The widened storage rack can accommodate 20 sets of LESMILLS barbells
- Equipped with friction-resistant washer

ITEM LP8859

- Size: 121.5Lx66.2Wx140.15H(cm)
- Weight: 55kg
- Assembly required



STUDIO STORAGE SYSTEM

Made of Q235 steel. Purpose Yoga Accessories. Hangs Exercise Mats & Organize Yoga Blocks, Foam Rollers, Gym Mats quickly and easily.

ITEM LP8872

- TUBE
- Size: 56x120x700mm
 - weight: 3.5KG



ITEM LP8872-C

- HOOK UP
- Size: 45x60x300mm
 - weight: 0.5KG



ITEM LP8872-D



ITEM LP8872-B



ITEM LP8872-M



ITEM LP8872-P

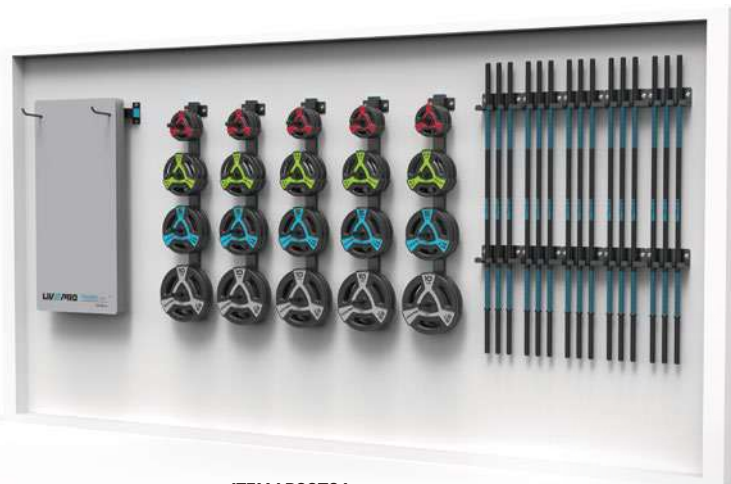

ITEM LP8872A



ITEM LP8872B

03

NEW FOR 2022

STRENGTH





PREMIUM URETHANE DUMBBELLS

- Weight increment:2kg-50kg
- High quality polyurethane material
- Special treatment alloy steel handle
- Sturdy dumbbell
- Tolerance: +/-2%
- 12mm thick polyurethane layer



12-SIDED URETHANE DUMBBELLS

- Weight increment:2kg-50kg
- High quality polyurethane material
- Special treatment alloy steel handle
- The strongest dumbbell
- Tolerance: +/-2%
- 12mm thick polyurethane layer



Structure

- Solid steel handles are hydraulically press fit through solid steel heads and are fully welded for maximum strength.
- The radius of each steel slug is chamfered on the outside to displace the force of the impact between the steel slug and urethane coating for longer impact resistance.
- Impact resistant matte finish urethane is low odor, will not crack or fade and prevents damage to floors and equipment.

Labels: Solid steel, Hard chrome Knurl

URETHANE DUMBBELLS

- Weight increment:2kg-50kg
- High quality polyurethane material
- Special treatment alloy steel handle
- Diamond knurling
- The most robust dumbbell
- Tolerance: +/-2%
- 8mm thick polyurethane layer



PREMIUM RUBBER DUMBBELLS

- Weight increment:2.5kg-50kg
- Made of natural rubber + butadiene rubber
- Special treatment alloy steel handle
- Diamond knurling
- Eight sided design that is stable and does not easily roll
- The rubber layer has a thickness of 15mm
- Tolerance: +/-2%



HEXAGONAL RUBBER DUMBBELL

- Weight increment:2.5kg-30kg
- Long curing time, better wear resistance
- Special treatment alloy steel handle
- The hexagonal design will not easily roll
- 12mm thick polyurethane layer
- Tolerance: +/-2%



URETHANE STUDIO DUMBBELLS

- Tolerance: +/-2%
- High-quality polyurethane material
- Special treatment alloy steel handle
- Most durable integrity construction
- The polyurethane layer is up to 8mm thick

Item	weight	Item	weight
LP8075-01	1kg	LP8075-06	6kg
LP8075-02	2kg	LP8075-07	7kg
LP8075-03	3kg	LP8075-08	8kg
LP8075-04	4kg	LP8075-09	9kg
LP8075-05	5kg	LP8075-10	10kg



COLORLED STUDIO DUMBBELL

- Weight increment:1kg-5kg
- High-grade PVC material
- More sturdy iron casting
- The 2mm thick PVC can effectively protect
- Anti-rolling ends
- Multiple color options

Item	weight	Color	Item	weight	Color
LP8076-01	1kg	Yellow	LP8076-03	3kg	Red
LP8076-1.5	1.5kg	Green	LP8076-04	4kg	Grey
LP8076-02	2kg	Blue	LP8076-05	5kg	Black



ADJUSTABLE DUMBBELL SET

The adjustable dumbbell set is much more intelligent than a single dumbbell. You can increase or decrease the weight of the dumbbell by adding or subtracting the adjustment pieces to meet your training needs at different times. You can exercise your strength and balance at the same time. The mechanism is simple. Just turn the handle to select the required weight, twist, peel, and lift up.

- High quality steel material
- Turn the handle to select the required weight
- Handle anti slip design
- Switch weight as you would like (2/4/8/12/16/20kg6)

- Material: Steel+ABS
- Land size: 67×54×69cm
- Pipe size: 50×50×2mm
- Shelf weight: 10kg
- Handle diameter: 36mm
- Handle length: 18.5cm
- Bell diameter: 18cm
- Bell plate width: 1.4cm
- Assembly required

Item	Specifications	Adjustable gear
LP8006-20	20kg	2 kg, 4 kg, 8 kg, 12 kg, 16 kg, 20 kg
LP8006-32	32kg	2 kg, 4 kg, 8 kg, 12 kg, 16 kg, 20 kg,24kg,28kg,32kg





URETHANE BARBELLS

- Weight increment:10kg-30kg
- High quality polyurethane material
- Special treatment alloy steel grip
- Most durable integrity structure
- The head is wrapped with a polyurethane layer
- Tolerance: +/-2%

ITEM LP8010

Item	weight
LP8010-10	10kg
LP8010-15	15kg
LP8010-20	20kg
LP8010-25	25kg
LP8010-30	30kg



EZ CURL URETHANE BARBELLS



ITEM LP8011

- Weight increment:10kg-30kg
- High-quality polyurethane material
- Special treatment for alloy steel grip
- Most durable integrity structure
- Crank design is wrist friendly with a different grip than straight bars
- The head is wrapped with a polyurethane layer
- Tolerance: +/-2%

Item	weight
LP8011-10	10kg
LP8011-15	15kg
LP8011-20	20kg
LP8011-25	25kg
LP8011-30	30kg



12-SIDED URETHANE BARBELLS

- Weight increment:10kg-30kg
- Tolerance: +/-2%
- High quality polyurethane material
- Special treatment for alloy steel grip
- Most durable integrity structure
- 12-sided anti-roll design on the head is designed for safer placement
- The head is wrapped with a polyurethane layer

ITEM LP8012

Item	weight
LP8012-10	10kg
LP8012-15	15kg
LP8012-20	20kg
LP8012-25	25kg
LP8012-30	30kg



12-SIDED EZ CURL URETHANE BARBELLS

ITEM LP8013

- Weight increment:10kg-30kg
- Tolerance: +/-2%
- High quality polyurethane material
- Special treatment for alloy steel grip
- Most durable integrity structure
- 12-sided anti-roll design on the head is designed for safer placement
- Crank design is wrist friendly with a different grip than straight bars
- The head is wrapped with a polyurethane layer

Item	weight
LP8013-10	10kg
LP8013-15	15kg
LP8013-20	20kg
LP8013-25	25kg
LP8013-30	30kg



URETHANE CHANGE PLATE

Livepro weight stacks are fixed by 45# steel core embryo, to ensure the hardness and stability of the weight plates. Their external high-quality polyurethane material is wrapped without hurting the floor while barbell is landed quietly. The weight plates are waterproof, wear-resistant, and can be used for a long time. There is a total of 6 colors to choose from weight plates, each color representing a different weight, and distinguishing the pickup easily.

ITEM LP8028

Item	Color	weight	Item	Color	weight
LP8028-0.5	White	0.5kg	LP8028-02	Blue	2kg
LP8028-01	Green	1kg	LP8028-2.5	Red	2.5kg
LP8028-1.5	Yellow	1.5kg	LP8028-5	Grey	5kg



URETHANE DOUBLE COLORED ELITE BUMPER PLATE

- Tolerance: +/-1%
- High-quality polyurethane material
- Alloy steel embryo
- Larger bearing capacity
- The thickness of the polyurethane layer is 21.5-54.3mm

ITEM LP8027

Item	Color	weight	Item	Color	weight
LP8027-05	Black	5kg	LP8027-20	Blue	20kg
LP8027-10	Green	10kg	LP8027-25	Red	25kg
LP8027-15	Yellow	15kg			



LIVEPRO ELITE BLACK RUBBER BUMPER PLATE

- Tolerance: +/-1%
- Made with new virgin rubber
- The thickness of the polyurethane layer is 28-91mm

ITEM LP8331

Item	Color	weight	Item	Color	weight
LP8331-05	Black	5kg	LP8331-20	Black	20kg
LP8331-10	Black	10kg	LP8331-25	Black	25kg
LP8331-15	Black	15kg			



LIVEPRO ELITE COLORED RUBBER BUMPER PLATE

- Tolerance: +/-1%
- Made with new virgin rubber
- Better abrasion resistance, and more elasticity
- The thickness of the rubber layer is 28-91 mm

ITEM LP8332

Item	Color	weight	Item	Color	weight
LP8332-05	White	5kg	LP8332-20	Blue	20kg
LP8332-10	Green	10kg	LP8332-25	Red	25kg
LP8332-15	Yellow	15kg			





STRENGTH

RUBBER COLORED COMPETITION BUMPER PLATE

- Made with 100% virgin rubber
- integrally formed at high temperatures
- Fall test: 30,000 times
- IWF standard manufacturing

ITEM LP8024B



Item	Color	weight
LP8024B-10	Green	10kg
LP8024B-15	Yellow	15kg
LP8024B-20	Blue	20kg
LP8024B-25	Red	25kg

RUBBER BLACK COMPETITION BUMPER PLATE

- Made with 100% virgin rubber
- integrally formed at high temperatures
- Fall test: 30,000 times
- IWF standard manufacturing

ITEM LP8025



Item	Color	weight
LP8025-10	Green	10kg
LP8025-15	Yellow	15kg
LP8025-20	Blue	20kg
LP8025-25	Red	25kg

BLACK HIGH ELASTICITY BUMPER PLATE

- Tolerance: +/-1%
- High-quality high-elastic rubber
- Higher elasticity, durability
- Fall test: 20,000 times
- IWF standard manufacturing

ITEM LP8026



Item	Color	weight
LP8026-05	Black	5kg
LP8026-10	Black/Green	10kg
LP8026-15	Black/Yellow	15kg
LP8026-20	Black/Blue	20kg
LP8026-25	Black/Red	25kg

RUBBER GRIP PLATE

- Available in a number of weights for different strengths
- Precision casting
- 50mm collar opening
- Impact resistant with reduced noise on drop
- Black Matte Finish
- Material: steel + rubber
- Olerance: +/-1%

ITEM LP8330



12-SIDED URETHANE GRIP PLATE

- Tolerance: +/-1%
- High quality polyurethane material
- The iron core is embedded in the barbell
- The strongest plates
- Hand grip hole design
- The 12 sided design effectively prevents the plates from rolling.
- The thickness of the polyurethane layer is 6-8mm

ITEM LP8023



URETHANE GRIP PLATE

- Tolerance: +/-1%
- High quality polyurethane material
- The iron core is embedded in the barbell
- Hand grip hole design
- The thickness of the polyurethane layer is 6-8mm

ITEM LP8020



WEIGHT LIFTING CHAINS

- Suitable for any Olympic bars.
- Lifting chains are made of steel with a zinc coat for high durability.

ITEM LP8089

Item	Weight
LP8089-05	5kgx2
LP8089-10	10kgx2
LP8089-15	15kgx2
LP8089-20	20kgx2



STRENGTH

Barbell poles are commonly divided into Olympic weightlifting poles and power weightlifting poles. The men's Olympic poles are 2.2 m in length and 20 kg in weight; The women's Olympic poles are 2.01 m in length and 15 kg in weight; the standard diameter of Olympic poles is 28 mm and the diameter of power poles is 29 mm

MEN'S WEIGHTLIFTING COMPETITION BAR

ITEM LP8050

20KG 28MM



WOMEN'S WEIGHTLIFTING COMPETITION BAR

ITEM LP8051

15KG 25MM



POWERLIFTING COMPETITION BAR

ITEM LP8080

20KG 29MM



PERFORMANCE WEIGHTLIFTING BAR

ITEM LP8052

20KG 28MM



	Item	Weight	Material	Shaft diameter	Length	Loadable Sleeve Length	Knurl	Tensile Strength	Tested	Sleeve Rotation
Men's Weightlifting Competition Bar	LP8050	20kg	60Si2Mn	28mm	220cm	41cm	IWF 1.2mm	190k PSI	1500LB	Needle bearing x 10, Bushing x 2
Women's Weightlifting Competition Bar	LP8051	15kg	CrMo	25mm	201cm	32cm	IWF 1.2mm	170k PSI	1500LB	Needle bearing x 4, Bushing x 2
Powerlifting Competition Bar	LP8080	20kg	60Si2Mn	29mm	220cm	41.5cm	IWF 1.2mm	240k PSI	2000LB	Needle bearing x 10, Bushing x 2
Performance Weightlifting Bar	LP8052	20kg	45#	28mm	220cm	41cm	Dual knurling 1.2mm	140k PSI	700LB	Needle bearing x 4, Bushing x 2



STRENGTH

MEN'S WEIGHTLIFTING BAR-CERAKOTE

20KG 28MM

ITEM LP8085



WOMEN'S WEIGHTLIFTING BAR-CERAKOTE

15KG 25MM

ITEM LP8086

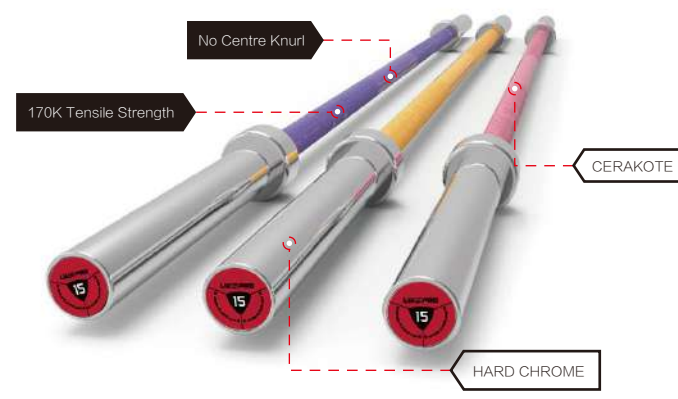

STAINLESS STEEL WEIGHTLIFTING BAR

20KG 28MM

ITEM LP8308



6' ALUMINUM OLYMPIC BAR

6.6KG 28MM

ITEM LP8088

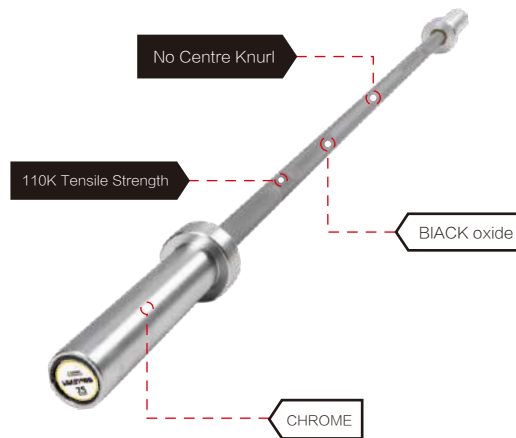

6' OLYMPIC BAR

15KG 28MM

ITEM LP8087

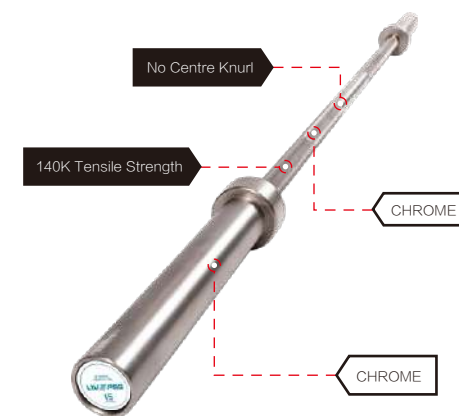

	Item	Weight	Material	Shaft diameter	Length	Loadable Sleeve Length	Knurl	Tensile Strength	Tested	Sleeve Rotation
Men's Weightlifting Bar-cerakote	LP8085	20kg	40Cr	28mm	220cm	41.5cm	IWF 1.2mm	160k PSI	1000LB	Needle bearingx8 Bushingx2
Women's Weightlifting Bar-cerakote	LP8086	15kg	42CrMo	25mm	201cm	32.7cm	IWF 1.2mm	170k PSI	700LB	Needle bearingx4 Bushingx2
Stainless Steel Weightlifting Bar	LP8308	20kg	Stainless steel	28mm	220cm	41cm	Dual knurling 1.2mm	170k PSI	1000LB	Needle bearing x 10, Brass bus hing x 2
6' Aluminum Olympic Bar	LP8088	6.6kg	Aluminum	28mm	183cm	23cm	Dual knurling 1.2mm	110K PSI	300LB	Ball bearing x 2, Bushing x 2
6' Olympic Bar	LP8087	15kg	Q235	28mm	180cm	31.5cm	Dual knurling 1.2mm	140k PSI	600LB	Needle bearing x 4, Bushing x 2



STRENGTH

DUFFALO BAR

22KG 30MM

ITEM LP8305

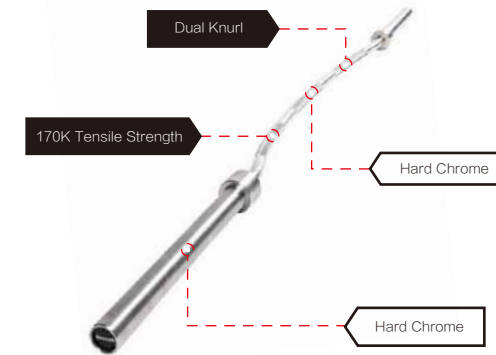

5' OLYMPIC BAR

13.5KG 28MM

ITEM LP8082

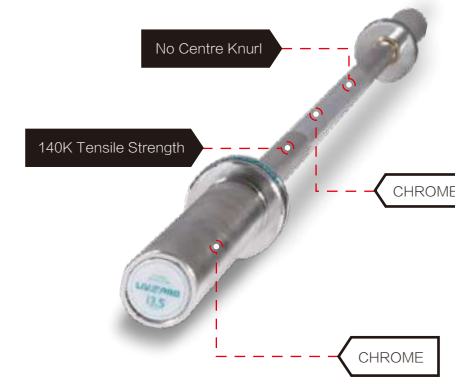

4' OLYMPIC BAR

10KG 28MM

ITEM LP8054

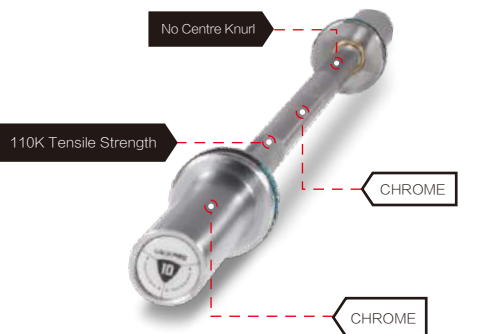

4' OLYMPIC CURL BAR

10KG 28MM

ITEM LP8053



JUNIOR TECHNIQUE BAR

2.5KG 22MM

ITEM LP8083



LOADABLE DUMBBELLS

5.8KG 28MM

ITEM LP8084



	Item	Weight	Material	Shaft diameter	Length	Loadable Sleeve Length	Knurl	Tensile Strength	Tested	Sleeve Rotation
Duffalo Bar	LP8305	22kg	42CrMo	30mm	235cm	48.2cm	Dual knurling 1.2mm	170k PSI	1000LB	Bushing x 2
5' Olympic bar	LP8082	13.5kg	45#	28mm	150cm	25cm	Dual knurling 1.2mm	140k PSI	600LB	Needle bearing x 2, Bushing x 2
4' Olympic Bar	LP8054	10kg	A3	28mm	120cm	17cm	Dual knurling 1.2mm	110k PSI	500LB	Bushing x 2 Bearing x 2
4' Olympic Curl Bar	LP8053	10kg	A3	28mm	120cm	17cm	1.2mm	110K PSI	500LB	Bushing x 2, Bearing x 2
Junior Technique Bar	LP8083	2.5kg	Alumimum	22.2mm	130cm	10.5cm	1.0mm	42k PSI	40LB	Ball Bearing x 2
Loadable Dumbbells	LP8084	5.8kg	A3	28mm	51.5cm	17cm	1.2mm	110K PSI	500LB	Needle bearing x 4



SAFTY SQUAT BAR

ITEM LP8055

The deep squat bar is equipped with protective equipment at the neck and shoulders to provide extra comfort, and the handles on both sides provide greater stability to keep the center of gravity centered when you are squatting.

- Tolerance: +/-1%
- Special quenching process
- Foam protection equipment
- Handle design on both sides

- Weight: 21kg
- Length: 220cm
- Fully welded design

21KG 28MM



HEX BAR

ITEM LP8309

The hex bar is made from high quality Q235 steel, the bar has higher strength and toughness, its weld- ability is better and it is more resistant to corrosion and not easy to rust. The two sets of knurling are designed to add aesthetic appeal and improve hand grip. During a workout, athletes can easily switch from one set of handles to another by simply flipping the bar over. the 6 side frame hard puller is very friendly to the lower back and is suitable for beginners.

- Tolerance: +/-1%
- Made of high quality steel material
- Extended handle design
- Two knurled designs

- Weight: 23.5kg
- Dimensions: 182 x 65 x 14.5cm



LOG BAR

ITEM LP8302

The handle is fully welded to the body, and the sturdy structure would make the workout more productive. The comfortable handle can maintain the center of gravity, reduce the pressure on the shoulder, and better suit for exercise and development of the strength of upper limbs, which is used to exercise the shoulder and back muscles.

- Tolerance: +/-1%
- Made of high-grade steel
- Corrosion-resistant and protected against rust
- Cylindrical design

- Length: 186cm
- Diameter: 21.5cm
- Weight: 25.88kg
- Fully welded design



HEX BAR

ITEM LP8300

Steel Deadlift Exercise Gear allows trainers to make deadlifting easily. Three diameters of the handle are available and well-tailored for challenging daily habits, allowing user to exercise from different angles. It contributes to the faster exercise of muscles and reduces the risk of injury by using appropriate materials. The knurled design on the handle offers a firm grip and makes workout safer. Coupled with barbell, it is believed to be one of the important exercise gears.

- Tolerance: +/-1%
- Made of high-grade steel
- Corrosion-resistant and protected against rust
- Knurled handle provides a firm grip.
- Three diameters of handle
- Four base props
- Length: 122cm



TRICEP BAR

ITEM LP8059

The length 86cm boxer is made of high-quality steel, the strength and toughness of the bar is higher, and its welding performance is better with more corrosion resistance and not easy to rust. The ergonomically designed handle can help triceps exercise, with knurled design handle which can provide better grip, comfort and safety. The sleeve is 50mm in diameter and 18cm long, which can be stacked with more weight, with a maximum load of 100kg.

- Tolerance: +/-1%
- Special quenching process
- Knurled handle design

- Weight: 10.6kg
- Length: 86cm
- Shaft diameter: 28mm
- Loadable Sleeve Length:18cm

10.6KG 25MM



MULTI-GRIP BAR

ITEM LP8301

Made of high-quality steel, the safety squat bar features multiple grip handles to target specific muscle groups or cater to those trainers with limited mobility. The different grips help engage different muscles in the barbell workout, at the same time allowing for a more natural grip position to help reduce the stress the barbell which exerts on the wrists and forearms.

- Tolerance: +/-1%
- Special quenching process
- Knurled handle provides better grip
- Multi-handle design
- Corrosion-resistant and not easy to rust

- Length:198.5cm
- Weight: 12.15kg
- Material: steel
- Shaft diameter: 28mm



FUNCTIONAL TRAP BAR

ITEM LP8310

The Open Hexagonal Frame Deep Squat Hard Pull Bar is designed for strength training and weightlifting, allowing hard pulling and shrugging exercises to be performed safely without the friction and stress of the bar. It is an improvement on the traditional hexagonal frame with a small but very important change that makes it very powerful and allows the trainer to enter and exit training mode freely. The knurled design on the handle provides a firm grip for a safer workout.

- Tolerance: +/-1%
- Made of high quality Q235 steel
- Corrosion resistant
- Knurled handle design for a stronger grip
- Tilted handle design
- Open design

- Dimensions: 212 x 60 x 15cm
- Load capacity: 700LB



FARMER'S WALK BAR

ITEM LP8307

Constructed from steel, black powdercoated finish. Making them ideal for training the lifts for the vast majority of users. These handles come complete with locking ring collars.

- Weight: 10.2KG
- Length: 150cm
- Pole diameter: 50mm
- Grip diameter: 30mm





STRENGTH

MULTI PURPOSE HANDLE

Connect to other equipment and equipment for combined use.

ITEM LP8192A



- Material: PU+Steel
- Size: 35.5x21cm
- Weight: 3.6kg

TRICEP V-BAR ROTATING

Connect to other equipment and equipment for combined use.

ITEM LP8192B



- Material: PU+Steel
- Size: 43.5x18.5cm
- Weight: 2678g

TRICEP ROPE

Heavy nylon material is made of downward pressure pulling rope, with high durability and resistant to continuous pulling.

ITEM LP8192C



- Material: Nylon+PE+Steel
- Length: 70cm
- Weight: 725g

CABLE HANDLE

Connect to other equipment and equipment for combined use.

ITEM LP8192D



- Material: PU+Steel
- Size: 17x15cm
- Weight: 860g

PRO LAT BAR

Connect to other equipment and equipment for combined use.

ITEM LP8192E



- Material: PU+Steel
- Size: 64x16x12cm
- Weight: 4.3kg

ANGLED BICEPS/TRICEPS BAR

Connect to other equipment and equipment for combined use.

ITEM LP8192F



- Material: PU+Steel
- Size: 62x23.5cm
- Weight: 2.9kg

ROWING HANDLE

Connect to other equipment and equipment for combined use.

ITEM LP8192G



- Material: PU+Steel
- Size: 18.5x15x13cm
- Weight: 1.89kg

TRICEPS STRAIGHT BAR

Connect to other equipment and equipment for combined use.

ITEM LP8192H



- Material: PU+Steel
- Size: 49x8.5cm
- Weight: 2.15kg

TRICEP V-BAR

Connect to other equipment and equipment for combined use.

ITEM LP8192I



- Material: PU+Steel
- Size: 32x18.5cm
- Weight: 1.95kg

BICEPS NARROW LIFT HANDLE

Connect to other equipment and equipment for combined use.

ITEM LP8326



- Material: PVC+Steel
- Size: 34.5x16x6cm
- Weight: 3.35kg

NARROW DISTANCE HOLDING HANDLE

Connect to other equipment and equipment for combined use.

ITEM LP8325



- Material: PVC+Steel
- Size: 34.5x16x6cm
- Weight: 3.35kg

HOLD DOWN HANDLE

Connect to other equipment and equipment for combined use.

ITEM LP8324



- Material: PVC+Steel
- Size: 43x14.5x6cm
- Weight: 3.65kg

ADDUCTION HANDLE

Connect to other equipment and equipment for combined use.

ITEM LP8322



- Material: PVC+Steel
- Size: 30.5x10x16cm
- Weight: 2.4kg

PULL OUT HANDLE

Connect to other equipment and equipment for combined use.

ITEM LP8323



- Material: PVC+Steel
- Size: 27.5x12x17.5cm
- Weight: 2.65kg

HOLD THE HANDLE

Connect to other equipment and equipment for combined use.

ITEM LP8321



- Material: PVC+Steel
- Size: 23.5x12.5x16.5cm
- Weight: 1.85kg

MEDIUM DISTANCE GRIP HANDLE

Connect to other equipment and equipment for combined use.

ITEM LP8329



- Material: PVC+Steel
- Size: 53x13.5x10.5cm
- Weight: 2.35kg

MEDIUM DISTANCE OUTWARD HANDLE

Connect to other equipment and equipment for combined use.

ITEM LP8327



- Material: PVC+Steel
- Size: 56x12x17.5cm
- Weight: 3.1kg

MEDIUM DISTANCE OUTWARD HANDLE

Connect to other equipment and equipment for combined use.

ITEM LP8328



- Material: PVC+Steel
- Size: 85x12x17.5cm
- Weight: 3.95kg

STRAP HANDLE PRO

Connect to other equipment and equipment for combined use.

ITEM LP8192J



- Material: TPR+PVC+Nylon+Steel
- Size: 13x3.4cm
- Weight: 268g

BARBELL COLLARS

- leather ring effectively protect
 - Nylon material has good wear resistance and is durable
 - Diameter is 50mm
 - Locking protection safety
 - Material: Nylon+TPPE
 - Weight: 130gx2pcs

ITEM LP8061



BARBELL COLLARS

- leather ring effectively protect
 - Nylon material has good wear resistance and is durable
 - Diameter is 50mm
 - Locking protection safety
 - Material: Nylon+TPPE
 - Weight: 130gx2pcs

ITEM LP8062



STRENGTH

JERK BOX

The JERK box is made of 20mm thick multi-layer panels that can withstand tremendous pressure as a way for athletes to focus on improving impact. Fitness boxes are available in four splits with heights of 6/15/30/38cm, with sturdy internal support for ultra-safe stacking, and stacked fitness boxes are most commonly used in weight training.

ITEM LP8816

- Made of high quality multi-layer board with a thickness of 20mm
- Double-layer structure with internal support
- Each layer of fitness box on both sides is designed with the hand grip holes



- Length: 915mm
- Width: 510 mm
- Detachable structure



- High: 38cm
- High: 30cm
- High: 15cm
- High: 6cm

BARBELL CUSHION

The barbell cushion is a product designed for weightlifting and powerlifting, which can greatly reduce the sound and vibration when the barbell falls and protect the barbell very well. Bottom anti-slip fabric increases the stability of the barbell table to ensure that the mat will not easily move when the barbell falls, which is very practical for both gym and home fitness.

ITEM LP8320

- High-quality PVC wrapping
- High-density recycled cotton filled
- Design with handles on two sides
- Anti-slip fabric at the bottom

- Mat: PVC+ recycled cotton
- Weight: 22kg/pair
- Size: 76x60x15cm



WEIGHTLIFTING BELT

This is a weightlifting belt made of heavy leather, ideal for those who require strength in a weightlifting belt. If you want to get into the traditional leather belt, this is a good choice for you.

ITEM LP8067

- High-quality cowhide material
- Waist protector cotton design
- The inner side of the waistband is made of suede
- Double claw buckle design
- Size: M:105x11cm L:130x13cm



WEIGHT BELT

This weight belt is a combination of PU material on the front and polyester on the inside, which is thick and tight, making it one of the more comfortable weight belts on the market.

ITEM LP8095

- Ultra-lightweight belt
- One size fits many body types
- Stainless steel chain
- Size: 99x19cm



NECKLACE

This neck workout harness and muscle strengthening strap is properly balanced to ensure it holds weight safely in place without pulling to either

ITEM LP8097

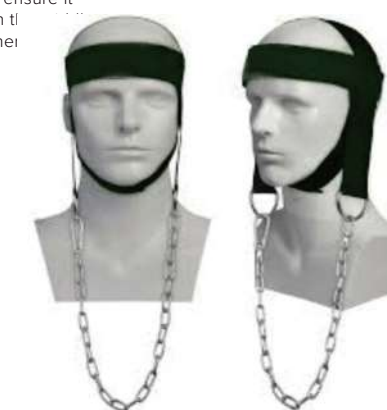



2 TIER DUMBBELL RACK

Used to store dumbbells

ITEM LP8898

- Double-layer design, can store hexagonal or square dumbbells
- Made of pure steel, strong and stable

- **Size: 200Lx69Wx85.5H(cm)**
- **Assembly required**



5 PAIRS DUMBBELL RACK

ITEM LP8902

- Double-layer design, can store 5 pairs of dumbbells
- The arc-shaped placement layer design makes the storage weight larger
- Designed for dumbbell storage

- **Size: 130Lx84Wx83H(cm)**
- **Assembly required**



10 PAIRS DUMBBELL RACK

ITEM LP8901

- Double-layer design, can store 10 pairs of dumbbells
- The arc-shaped placement layer design makes the storage weight larger
- Designed for dumbbell storage

- **Size: 245Lx84Wx83H(cm)**
- **Assembly required**

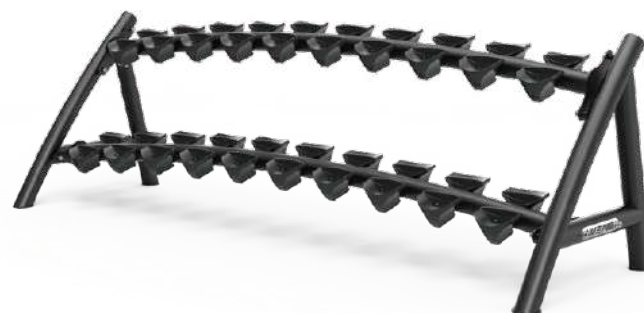

15 PAIRS DUMBBELL RACK

ITEM LP8903

- 3-layer design, can store 15 pairs of dumbbells
- The arc-shaped placement layer design makes the storage weight larger
- Designed for dumbbell storage

- **Size: 245Lx104Wx99H(cm)**
- **Assembly required**



DUMBBELL TREE

ITEM LP8860

This cylindrical vertical dumbbell tree is the ideal dumbbell storage solution for gyms, whether you are in a commercial health club or home gym, to keep your free strength area organized. The metal frame with a matte black finish looks very textured and it combines an aesthetically pleasing design with high-quality materials for an overall aesthetic look. The wide base provides extra stability.

- With 2mm thick pipe, with seamless welding technology
- Black frosting sprayed
- 4 anti-slip bottom brace on the base

- **Size: 49Lx49Wx132H(cm)**
- **Weight: 35kg**
- **Assembly required**



PLATE RACK

ITEM LP8904

The black matte surface on the metal frame looks very textured. Made of durable metal steel material, not easy to rust, beautiful and atmospheric. The perfect combination of triangle and arc can provide higher stability and load-bearing capacity. It is currently the perfect ring storage rack on the market.

- **Size: 70.4Lx67.6Wx88.3H(cm)**
- **Assembly required**



HORIZONTAL PLATE RACK

ITEM LP8810

This 8-compartment slot weight plate rack is the ideal weight plate storage solution for gyms, whether you are in a commercial health club or a home gym. The metal frame with a matte black finish looks very textured and it combines an aesthetically pleasing design with high-quality materials for an overall aesthetic look. Wide support leg is for extra stability and rubber feet on the bottom protects the floor from scratches.

- Made of high-quality with seamless welding technology
- Black frosting sprayed
- Convenient handle and wheel design

- **Size: 127Lx48Wx33H(cm)**
- **Assembly required**



VERTICAL PLATE AND BAR TREE

ITEM LP8851

This vertical plate and bar tree is the ideal weight plate and Olympics bar storage solution for the gym, whether you are in a commercial health club or a home gym.

- With pipe being 3mm thick with seamless welding technology
- Black frosting sprayed
- Weight plate storage bar is treated by electroplating
- The inner side of the weight plate storage rod has a leather ring
- Protect the ground and be anti-slip

- **Size: 77Lx54Wx124H(cm)**
- **Weight: 36kg**
- **Assembly required**



HORIZONTAL PLATE RACK

ITEM LP8900

The metal frame and the black matte surface look very textured. It combines beautiful design and high-quality materials, and the overall beautiful atmosphere. The wide support feet provide extra stability. There are rubber feet on the bottom to protect the floor from scratches.

- **Size: 130.4Lx38.6Wx30.6H(cm)**
- **Assembly required**





5 BARBELL RACK

This 5 barbell rack is the ideal Olympics bar storage solution for gyms, whether you are in a commercial health club or a home gym. The metal frame with a matte black finish looks very textured and it combines an aesthetically pleasing design with high-quality materials for an overall aesthetic look. Wide support provides additional stability with rubber legs at the bottom to protect the floor from scratches.

ITEM LP8852

- With pipe being 2mm thick with seamless welding technology
- Black frosting sprayed
- Protect the ground and be anti-slip
- Used for Olympics bar
- It covers a small area and optimally uses floor space

- **Size: 85L×70.5W×131H(cm)**
- **Weight: 34.5kg**
- **Assembly required**



ITEM LP8853

10 BARBELL RACK

This barbell rack is the ideal barbell storage solution for gyms, whether you are in a commercial health club or a home gym. The metal frame with a matte black finish looks very textured and it combines an aesthetically pleasing design with high-quality materials for an overall aesthetic look. Wide support leg provides additional stability with rubber legs at the bottom to protect the floor from scratches.

- With 2mm thick pipe, with seamless welding technology
- Black frosting sprayed
- Protect the ground and be anti-slip
- Used to store up to 10 barbells

- **Size: 83L×85W×125H(cm)**
- **Weight: 56.5kg**
- **Assembly required**



ITEM LP8874

9 BAR HOLDER

This 9 bar holder is the solution for storing the Olympics bars in the gym. Because the Olympics bars are round and roll easily on the floor, which is the ideal solution to keep the gym floor neat and orderly and the safety of Olympics bars. 6.5mm thick metal steel frame with black matte finish looks very quality. The stand is designed with nine 51mm inner diameter Olympics bars jacks, which makes it easy to store the rod vertically and safely.

- With 6.5mm thick pipe, with seamless welding technology
- Black frosting sprayed
- Vertical storage is designed, covering a small area
- Protect the ground and be anti-slip

- **Size: 44L×44W×16.5H(cm)**
- **Weight: 21kg**



6 BAR GUN RACK

The 6 bar gun rack is the ideal barbell storage solution for gyms, whether you are in a commercial health club or a home gym. It doesn't take up floor space, is stable and secure, and is stored fixed in the slot so it won't move around. The metal frame with a matte black finish looks very textured and it combines an aesthetically pleasing design with high-quality materials for an overall aesthetic look.

ITEM LP8812

- Made of high-quality steel with seamless welding technology
- Unique slot is designed and the rod can be safely placed which is not easy to fall
- With clever wall-mounted design, it does not occupy the ground space
- Used to store barbells and can store up to 6

- **Size: 98cm**
- **Weight: 9.5kg**
- **Assembly required**



VERTICAL BAR HANGER

This vertical bar hanger is the ideal Olympics storage solution for gyms, whether you are in a commercial health club or a home gym. The metal frame with a matte black finish looks very textured, and it blends beautiful design and high quality materials for an overall beautiful atmosphere. The shelf can be fixed to the wall, which is strong and durable, and very stable.

ITEM LP8891

- With High-quality Q235 pipe
- Adopt seamless welding technology
- Black frosting sprayed
- Suitable for Olympics storage
- Four expansion screws to fix

- **Material: Q235**
- **Size: 8.7L×10.6W×32H(cm)**
- **Weight: 6.5kg**
- **Assembly required**



VERTICAL PLATE HANGER

This vertical plate hanger is the ideal weight plate storage solution for gyms, whether you are in a commercial health club or a home gym. With a metal frame plus a matte black finish for a very textured look. It combines an aesthetically pleasing design with high quality materials for an overall aesthetically pleasing look. The shelf can be fixed to the wall, which is sturdy, durable and very stable.

ITEM LP8893

- With high-quality Q235 pipe
- Adopt seamless welding technology
- Black frosting sprayed
- The shelf is fixed on the wall, not occupying the floor space

- **Material: Q235**
- **Size: 6.4L×24.7W×120H(cm)**
- **Weight: 9kg**
- **Assembly required**



PLATE AND BAR STORAGE SET

This storage set is the ideal barbell set storage solution for the gym. Whether you are in a commercial health club or a home gym. With a metal frame plus a matte black finish for a very textured look, it combines an aesthetically pleasing design with high quality materials for an overall aesthetically pleasing look. The shelf can be fixed to the wall and floor, which is sturdy, durable and very stable.

ITEM LP8894

- With high-quality Q235 pipe
- Adopt seamless welding technology
- Black frosting sprayed
- Suitable for barbell sets
- Anti-scratch leather ring of weight plates

- **Material: Q235**
- **Size: 100L×40.1W×180.9H(cm)**
- **Weight: 28kg**
- **Assembly required**





GLUTE HAM DEVELOPER

GHD is a very popular tool for strength and rehabilitation training. It is an important equipment for exercising buttocks, back chains, waist, hamstrings and even core exercises. GHD can be adjusted horizontally and vertically to ensure that users get the correct fit. GHD improves athletes' speed, strength, and explosive power. The benefits of separate training for hips, hamstrings, and back chains are obvious.

- Suitable for gluteal muscles, waist and hamstrings
- Adjustable pedal
- Wide base to ensure stability

- **Size: 181L×97W×118H(cm)**
- **Weight: 78kg**
- **Assembly required**



ITEM LP6066

LIVEPRO DONKEY

The Sorinex Original Frankenhyper was created in 2013 and combines the Glute Ham with a pendulum hip extension. Add plate storage, ball storage and a tab for handles that allow you to increase upper body work capacity, and you have a monster posterior chain training machine that only takes up a few square feet of space in your facility. The Frankenhyper allows for the entire rear of the body to be worked through contraction and decompression unlike anything before. The pendulum style weight arm is used for swinging hip extensions and can also be used for upper body movements like rows, face pulls, bicep curls, triceps, pull thru's, presses, TKE's, YTM's. Incorporate abdominal movements in the supine position with integrated med ball storage with in arm sreach. Each Frankenhyper comes standard with bumper weight plate storage and band attachment points.

- Made of high-quality steel pipe
- The bottom 7-position adjustment lever can adjust the flexion angle to meet any exercise needs
- Comfortable cushion
- Height adjustment

- **Size: 180L×91W×139H(cm)**
- **Assembly required**



ITEM LP6069

PRO ADJUSTABLE BENCH

The pro adjustable bench can be adjusted in 6 steps, and the polyurethane wheels make it easy to enter and exit the work area. The frame is made of steel pipes, and all open ends are covered with welded steel or rubber. All connecting bolts are equipped with anti-vibration locking system. The backrest is stable and durable, high-density and waterproof. High-elastic foam padding and high-quality leather wrap on the surface. When not in use, the bench can be stored upright.

- **Size: 138x68.6x44.5(cm)**
- **Weight: 200kg**
- **Tube size: 50x80x2.5mm**
- **Cushion adjustment angle: 0°, 20°**
- **Backrest adjustment angle: 0°, 15°, 30°, 45°, 60°, 75°**
- **Assembly required**



ITEM LP6067



SINGLE LEG SQUAT

This single leg squat rack has an ergonomic design. 13 height-adjustable holes and a swivel foam footrest keep your feet firmly on the curve. Made of high quality steel, strong and durable. The adjustable single-leg squat rack allows students to comfortably perform single-leg exercises such as the single-leg bench squats, Bulgarian splits, and rear-foot over-head splits.

- Made of high-quality steel pipe
- There are a total of 13 height adjustment holes with a spacing of 2.5cm
- Comfortable foot rest

- **Size: 53×58×58cm**
- **Weight: 14.5kg**
- **Assembly required**



ITEM LP6070

FLAT BENCH

- The flat weight bench is made of heavy-duty steel tube which ensures more sturdiness and durability.
- It can be used for abdomen and leg work out, strength training exercises, free weights, push up and back sit up.
- The thick padded seat provide maximum comfort.

- **Material: steel+PU+sponge+recycled cotton**
- **Size: 117×50×45cm**
- **Weight: 22kg**
- **Assembly required**



ITEM LP6060

ADJUSTABLE BENCH

This multi-functional exercise bench can provide you with a variety of exercises. High-quality fitness chair can guarantee your safety. Mechanical support, stable and safe, provide more stability and safety for your sports. Comprehensive equipment for full body exercise. It is very suitable for biceps, bench press, shoulder press, abdominal muscle training, leg exercise and so on.

- **Material: steel+PU+sponge+recycled cotton**
- **Size: 99×66×140cm**
- **Weight: 36kg**
- **Assembly required**



ITEM LP6061



SQUAT STAND

Squat stand is offered in several options of customizable colors, with an upper bar for height configuration. You can easily configure a suitable height according to height for safe exercise. This product is tailored for squat, bench press, pull-up, and press-down. Four PVC bottom pads which directly contact the floor can maximize stability.

ITEM LP6000

- This product is made of Q235 high-grade steel, laser cut and welded seamlessly, which tends to be more firm and durable.
- Applied with blue color powder coating
- Holes are evenly distributed across the stand column, allowing for free adjustable height of hooks whenever necessary.
- The steel pipes on the base are securely coupled to the vertical pipes by triangle pieces.

- Brand: Livepro
- Color: Black and blue
- Material: Steel
- Weight: 85kg
- Product dimensions: 125×138×230cm
- Steel pipe size: 75×75×3mm



INDEPENDENT SQUAT STAND

Independent squat stand is offered in several options of customizable colors, with an upper bar for height configuration. You can easily configure a suitable height according to height for safe exercise. Split Steel Squat Rack with flexible and freely adjustable width is tailored for squat, bench press, pull-up, and press-down. Four PVC bottom pads which directly contact the floor can maximize stability.

ITEM LP6001

- This product is made of Q235 high-grade steel, laser cut and welded seamlessly, which tends to be more firm and durable.
- Applied with blue color powder coating
- Holes are evenly distributed across the stand column, allowing for free adjustable height of hooks whenever necessary.
- Split type, flexible rack width can be adjustable whenever necessary.
- The steel pipes on the base are securely coupled to the vertical pipes by triangle pieces.

- Brand: Livepro
- Color: Black and blue
- Material: Steel
- Weight: 50kg
- Single stand dimensions: 56×78×184cm
- Steel pipe size: 60×60×3mm



HD ATHLETIC BASE HLAF RACK

This facility is a heavy-duty, sturdy, ultra-large tube structure squat rack that is commercially available in the market. The construction made of 75×75 mm steel frame and bolting connection made it more stable.

ITEM LP6002

The four-side hole design with 1,184 master holes provides unbounded workout potentials. As constructed in consideration of scalability instead of substitution, the squat rack will accompany with your growth by new accessories and customizable storage. Potentially as the rack with most extensive applications than ever, it allows for more persons to train in a venue and improves the accommodation capacity in your venue.

- This product is made of Q235 high-grade steel, laser cut and welded seamlessly, which tends to be more firm and durable.
- The surface is applied with blue color powder coating and subject to heat treatment, and the matte coating would lead to better hand feel and texture, which appears to be nice and solid. All areas are finished by special sandblasting and chemical cleaning, followed by painting process, which provides stronger resistance to corrosion and better protection against rust.
- With 4 pieces of stand columns, holes are evenly distributed across the stand columns on four sides, there are 1,184 master holes provided on the product. Hooks can be freely adjustable according to workout needs, offering unbounded workout potentials.
- Multiple storage sites
- 240kg power rack can bear a load up to 2000kg.
- Bars and hooks are protected by PP boards to shield from scratch
- 7 colors are available for customization

Material	Weight	Tube size	Length	Width	Height	Max. Load
Steel,plastic	240kg	75×75×0.3cm	190.5cm	180.5cm	249.5cm	2000kg





HD ATHLETIC BASE POWER RACK

This rack is a part of Livepro' s heavy duty series. On the market, it is a super large and strong structure squat rack. It is an upgraded version of the half frame strength training rack. It is made of 75x75mm steel frame and bolted to provide higher stability. The rack' s four way hole design has a total of 1452 holes and provides unlimited training possibilities. It is built in consideration of expansion and not replacement. As your abilities increase, the squat rack will grow with you with new accessories and customizable storage. It is the most versatile rack ever that allows multiple people to train on one site. Therefore, it can increase the capacity of your training facility.

- This rack is made of Q235 high quality steel that is laser cut with seamless welding technology making it more stable and durable
- The surface of the rack is sprayed black and treated with high temperatures. The matte coating increases the rack' s feel and texture. The coating is both beautiful and thick.
- With six uprights. The hooks can be freely adjusted according to training requirements and provides unlimited training possibilities.
- The rack' s 10 bell hanging rods can accommodate multiple complete sets of bells.
- The 280kg training rack can bear 2000kgs.
- There are a total of 7 colors to customize the rack.
- The bottom is contacted with the ground with six films to increase stability of the rack
- There is a PP board between the pole and hooks to prevent scratches.
- Custom Logo and color Options

ITEM LP6003



Material	Weight	Tube size	Length	Width	Height	Max. Load
Steel,plastic	280kg	7.5x7.5x0.3cm	190.5cm	246.5cm	249.5cm	2000kg

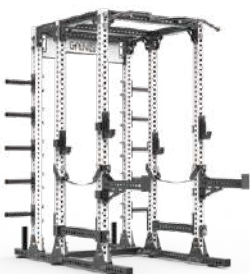

LIVEPRO SELECTORIZED RACK

The original intention behind the design of the HLP rack is to use it to replace three large, heavy, and expensive equipment. It is designed to replace a squat rack, backdrop rack, and a functional trainer. The rack hopes to provide the best performance, be more useful, and provide better quality at the price of regular household appliances. Each rack is equipped with standard J-hooks and protective arms, making it a perfect base for various accessories. The two 100kg weight sets have built in rods with double high and low pulley systems. The customizable frame can accommodate multiple forms of training at one time. The weight that it comes with is enough to challenge even the strongest weightlifters.

- This rack is made of Q235 high quality steel that is laser cut with seamless welding technology making it more stable and durable.
- Each piece is exposed to special sandblasting and a chemical cleaning process. Then, it is painted to increase corrosion resistance, thus will not easily rust.
- The hook can be adjusted freely
- Multiple storage positions
- The rack has 75x75x3mm pipes, can bear an overall weight of 455kg, and is extremely load bearing.
- This rack comes with a counterweight that can be freely adjusted.

Contain:

- 1 pair of safety frames
- 1 pair of hooks
- 6 bells hanging rod
- 2 barbell bar racks
- 1 set of rowing pedals
- 1 set of high drop down cushion
- 1 set of adjustable pull-up frame
- 2 simple pull handles
- 2 grip power ball
- Single side 100KG select iron

- Color: Black
- Weight: 455kg
- Material: Steel+PP
- Size: 194.5(L)x178.6(W) x240.6 (H) cm

ITEM LP6004

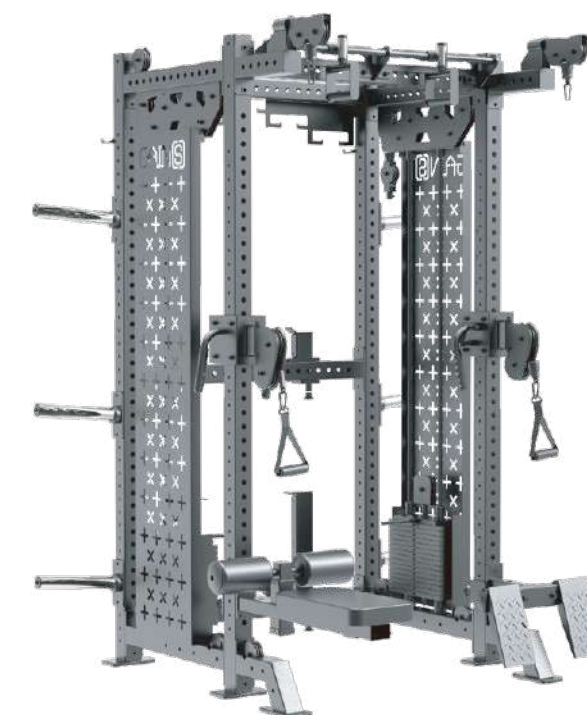

LAT PULLDOWN/LOW ROW

Lat pulldown/low row is one of the best pieces of equipment you can add to your home gym. Lat pulldown/low row can open up several good exercises, not just for your lats but also for your entire back, your arms, abs and shoulders.

- Material: Steel
- Colour: Black
- Size: 141.3(L)x124.3(W)x230.3 (H) cm
- Weight: 180kg
- Maximum load-bearing capacity: 200kg
- Assembly required

- Counterweight: 100kg
- Number of counterweights: 22

ITEM LP6005





STRENGTH

WEIGHTLIFTING PLATFORM

The largest weight-bearing platform designed for weightlifting and powerlifting, there are two options for cushioning thickness, 40 and 80mm. The left and right rubber cushioning pads are of a single-piece structure, and the bottom is recycled cotton, which provides stronger cushioning and stronger noise reduction. The combat area is composed of a 40mm/80mm thick non-slip multi-functional platform. The heavier weight and special treatment on the surface make the entire platform more non-slip.

- 40/80mm cushioning thickness
- Durable rubber provides ample cushioning for the landing of the bell plate.
- Huge multifunctional platform provides anti-slip protection.
- Abrasion-resistant, dirt-resistant, water-resistant
- High strength iron frame
- Can bear more than 500kg
- Easy to assemble, with clear and easy-to-understand assembly instructions
- Customizable LOGO

Item	Size	Thickness
LP6033	2580×2080mm	40mm
LP6034	2600×2100mm	80mm



ITEM LP6033

ITEM LP6034

RUBBER LIFTING PLATFORM

This professional rubber lifting platform consists entirely of granulate plates. The external dimensions of the platform are: width 2580mm x depth 2080mm, width 2600mm x depth 2100mm the cushioning height is 40 and 80mm.

- Thickness: 40/80mm
- Pressed in one piece
- Robust steel frame made of thick-walled square steel tube
- Stress level + up to 400 kg
- Extra sound-absorbing
- Non-slip

Item	Size	Thickness
LP6031	2580×2080mm	40mm
LP6035	2600×2100mm	80mm



ITEM LP6031

ITEM LP6035

LIFTING PLATFORM FOR POWER RACK

The Lifting Platform for Power Rack features our (40/80)mm thick High-Impact CrossFit Gym Tiles and the appropriate beveled edge tiles, including connection push-pins, for a walk-in ramp. The beveled edge is also an important feature to comply with UK health and safety regulations. Proving a cost-effective option for home gyms and commercial gyms, these lifting platforms feel good underfoot and prove great at absorbing impact.

- 40/80mm for cushion height
- Durable solid rubber discharge plates with shock absorption system
- Massive multiplex board with non-slip surface sealing
- Abrasion-resistant, insensitive to dirt, water-repellent
- Robust steel frame made of thick-walled square steel tube
- High stress level + up to 500 kg
- With shock absorption system
- Platform is delivered disassembled
- Quick and easy assembly, including assembly instructions
- Custom logo option

Item	Platform board size	Embedded board size	Thickness
LP6032	2580×2080mm	1100×1550mm	40mm
LP6036	2600×2100mm	1100×1550mm	80mm



ITEM LP6032

ITEM LP6036

STRENGTH

SERVO MOTOR RESISTANCE TRAINING SYSTEM

Using advanced control computer and servo motor technology, the motor can be accurately controlled at a control frequency of more than 2000Hz, and the training data can be recorded and displayed at the reaction speed of more than 200Hz, which fully meets the test and training requirements.

The servo motor realizes digital precision control of resistance and speed as well as feedback of key data. The resistance accuracy is as high as 0.1lb and the speed accuracy is up to 0.1m/s. Thus, it can accurately collect motion information and accurately control the output of resistance. It can not only continuously provide constant resistance, but also meet the specific effect resistance of actual training requirements.

12 gear adjustment in vertical direction, 120mm-2400mm; 5 gear adjustment in horizontal direction, 600mm-2300mm

Technical specifications:

- Continuous centripetal force setting: 0.5kg-32kg (1lbs-70.5lbs)
- Continuous centrifugal force setting: 0.5kg-32kg (1lbs-70.5lbs)
- Centripetal speed: 0.1-8.0m/s (0.3-26ft/s)
- Centrifugal speed: 0.1-8.0m/s (0.3-26ft/s)
- The highest point of the rope: 2.4m (7.8ft)
- The lowest point of the rope: 0.1m (0.4ft)
- The maximum horizontal distance between the ropes: 2.3m (7.5ft)
- Minimum distance between ropes: 0.6m (2.0ft)
- Maximum rope length: 4.0m (13.1ft)
- Maximum centripetal/centrifugal force 32kg/70.5lbs continuous: 100S
- Weight: 270kg (595lb)
- Clear height: 1.63m (5.3ft)
- Equipment size (mm): deep * section * high: 1375*2046*1647
- Leveling angle of display interface: 5°-20°
- Training control frequency: 2000Hz
- Curve display frequency: 200Hz
- 12 inch capacitive touch screen, resolution 1024*768
- Servo motor provides resistance
- Centripetal force, centrifugal force, centripetal speed, centrifugal speed are individually and continuously adjustable, and the force adjustment accuracy is 0.1lb

- The system collects and records training data in real time, and displays the curve in real time, and can be stored in the cloud
- Coach action demonstration function at any time, modify sports setting parameters (demonstration action data does not affect normal training data)
- Training plan management: can manage athlete data and make different plans based on test results
- Software function: 7 kinds of training mode selection, custom parameter setting (centripetal force, centrifugal force, centripetal speed, centrifugal speed).
- Support Chinese and English display
- Data recording and viewing: the panel records the training data in real time, and the curve coordinate display content is optional: X axis: position, time; Y axis: power, power, speed; histogram: peak power, average power, peak speed, average speed, Force development rate (RFD)
- Multiple training modes and inertia compensation to adapt to different types of sports. Constant isotonic, centrifugal isotonic, centripetal isotonic, centripetal constant velocity, no inertia, elastic resistance, fluid resistance.
- Web segment data management system, exportable to Excel file format
- Support mobile APP to log in to the device. After the device is connected to the Internet, personal plan issuance and training data upload.

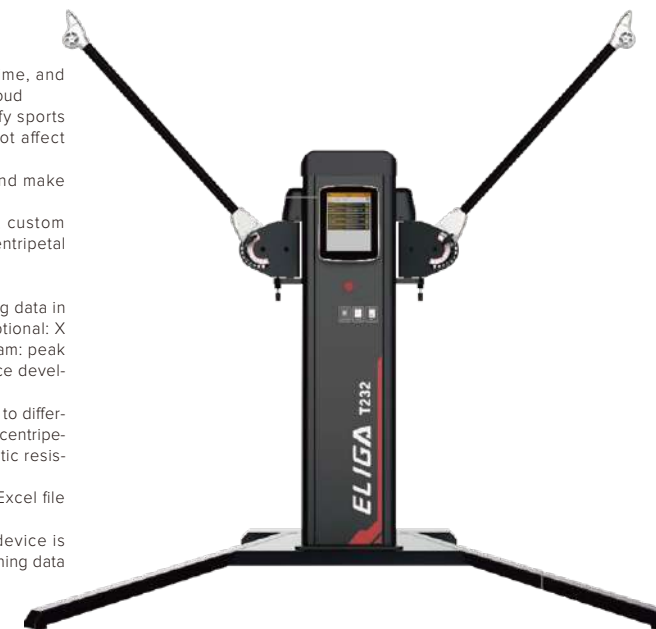

ITEM ELIGA-T232

DIGITAL MULTIFUNCTIONAL TRAINER

Used in aerospace, high-speed rail, elevators and other fields, with a control frequency of more than 2000Hz, the motor can be precisely controlled to provide the resistance and speed required for training at all times. It adopts the interactive interface of text + picture combination. It is rich in color and intuitive in content. The operation is simple and easy to understand. And it can easily guide and start training.

- Digital function
- Digital display
- Initial parameter setting
- Real-time data display and recording
- Data fitting, comparative analysis
- Mobile APP mode
- Develop a training plan
- Choose your own account
- Real-time recording of mobile phone data
- WEB side
- Real-time recording and analysis to ensure scientificity and safety.
- Size: 2800x1916x2345mm

Multiple training modes

- Constant isotonic resistance mode
- Centripetal isotonic resistance mode
- Centrifugal isotonic resistance mode
- Elastic resistance mode

Sport mode

- Expert mode
- Muscle training mode
- Special course
- Customized course

Core advantages

- Multi-resistance exercise mode
- High precision
- Multi-port data real-time display and recording
- Multi-parameter indicators



ITEM ELIGA-S230M

04

NEW FOR 2022

STABILITY & RECOVERY

www.livepro-fitness.com

STABILITY & RECOVERY



ITEM LP8201

ANTI-BURST CORE BALL

This anti-burst core ball has different sizes and colors, so you can freely choose it according to your height. The unique anti-burst technology ensures that it can withstand years of regular use, and the ball has a high load capacity, which can withstand 400kg of weight by test.

- Multiple sizes chosen (55/65/75cm)
- Better grip and friction
- Tested to exceed 800kg

Item	Size	Height
LP8201-55	55cm	5' - 5'7"
LP8201-65	65cm	5'8" - 6'3"
LP8201-75	75cm	over 6'3"



BLANCE TRAINER

Balance trainers are used for balance training. Whichever exercise is taken, the unstable surface coupled with core muscles can improve balance and stability, give user an access to more dynamic exercise.

- 3D features added to action
- Handle design increases the possibility of exercise
- Black texture surface increases the coefficient of friction and shields from slippage.
- Size:103×48.5×25cm(air inflation)

ITEM LP8216



BALANCE BOARD

The balance board is ideal for injury rehabilitation, improving balance and increasing strength and stability in your core muscles.

ITEM LP8214

- Size: 59x42x11.5cm
- Weight: 300g
- Mat: PVC



BALANCE TRAINER

Fitness balance hemisphere can be used for balance training and core muscle exercise, and improve coordination, muscle strength and flexibility. Standing, jumping and push-ups can be completed on it, and even you can also carry out more daring challenges.

ITEM LP8211

- High-quality PVC material
- Anti-slip design
- Maximum User Weight: 300kg
- Height: 22cm
- Diameter: 61.5cm
- Weight: 5.2kg



www.livepro-fitness.com

NEW FOR 2022 56



EXERCISE STICK

Help you to shape body, slim waist and give you attractive figure. Comfortable feel, logs are completely cuts, straight and no deformation. Does not hurt hands, no burrs, with polishing process, comfortable feel.

- Made of wood material, durable, safe and environmentally friendly.

ITEM LP8266



Item	Specifications
LP8266-120	120x2.5cm
LP8266-150	150x2.5cm

STRETCH BOARD

Relieve joint strain, joint sprain, arch pain and plantar fasciitis, achilles tendinitis and other foot pain. Helps restore flat feet, arches, valgus, inverted X-shaped legs, and O-shaped legs.

- Environmentally friendly materials, odorless, durable, corrosion-resistant, easy to clean, and not deformed
- Weight: 4.88kg
- Size: 46x38x5.8cm

ITEM LP8363



BALANCE PAD

Balance pad has now been widely used to improve muscle and joint strength, exercise the sense of balance and human coordination.

- High-quality polyurethane material
- Stable and anti-slip
- It is waterproof internally, which is easy to clean
- Size: 49x39x5.5cm

ITEM LP8360



BALANCE BOARD

- Template with thickness of 1.8cm is heavy load-bearing and safer to use

- High-quality birch wood material
- Anti-slip design of surface layer
- Size: 80x26x1.8cm
- Roller diameter: 11cm
- Roller length: 18cm

ITEM LP8362



FOOT MASSAGE BALL

- Designed for the soles of the feet and small muscle groups
- High-quality polyurethane material
- Unique design pattern and texture
- Diameter: 6.8cm

ITEM LP8507



TARGET MASSAGE BALL

- High-quality polyurethane material
- Unique design pattern and texture
- Portable and easy to use
- Weight: 238g
- Diameter: 12.5cm

ITEM LP8508



PEANUT MASSAGE BALL

- Size: 19.4x10.6cm
- Weight: 250g

ITEM LP8509



CONDENSED PEANUT MASSAGE BALLS

Livepro Massage Balls provide targeted cold compression massage therapy to help reduce joint inflammation and muscle pain.

- Food-grade stainless steel
- Ergonomic Handle
- Three in one for quick recovery
- Size: 17.5x9.3cm
- ball diameter: 35mm

ITEM LP8511



MAGNETIC MASSAGE STICK

Livepro magnetic massage stick is ergonomically designed, which is composed of three rollers containing magnets, two handles and one roller.

- Magnetic therapy
- Ergonomic design
- Pressure control
- Length: 41.5cm

ITEM LP8264



MASSAGE GUN

The Livepro massage gun is an innovative massage tool. The outer case is made of aviation-grade aluminum that is light, high strength, and durable. It has a hand held design with a unique high-torque motor that switches at the bottom end. There are a total of four turn speed adjustments (1800, 2100, 2400, 3200).

ITEM LP8513

- Made of high quality aviation grade aluminum
- Four different adjustable speeds (1800/2100/2400/3200)
- The extended motor works no matter how deep the gun is pressed
- You can switch between fitness and physiotherapy modes by pressing the power button twice
- 5 massage heads (spherical head, Y-shaped head, tapered head, flat head, and golden finger)
- 2000mAh rechargeable lithium-ion battery
- Size: 15.1x9x4.6cm





EVA FOAM ROLLER

- Light and durable high-density EVA
- Two lengths, 45cm and 90cm
- Design of salient points
- Color: Black

ITEM LP8230



Item	Length	Diameter
LP8230-45	45cm	15cm
LP8230-90	90cm	15cm

HIGH-DENSITY FOAM ROLLER

Compared to the Livepro foam roller, this foam shaft provides a higher density for rolling tight large muscle groups and knots to reduce soreness and improve mobility. Regular use of the roller can provide benefits such as increased flexibility, improved balance and mobility, and readiness for optimal athletic performance.

ITEM LP8238

- Strong and durable high-density EPP
- Color: black+blue



Item	Length	Diameter
LP8238-45	45cm	15cm
LP8238-90	90cm	15cm

FORM ROLLER

- Durable EVA environmental protection material
- Muscle area: arm, sole of foot, neck shoulder, leg, thigh
- The inner tube is made of high-strength industrial material, bearing 200kg, avoiding bending and fracture.
- Innovative massage area design
- Size: 33x13cm

ITEM LP8231



VIBRATING FOAM SHAFT

- 4-Speed vibration technology
- The rechargeable battery can last for 6 hours and can be used for 8 hours with frequency conversion.
- Three types of surfaces
- Size: 33x14cm
- Weight: 1350g

ITEM LP8236



FOAM ROLLER

Massage allows muscle relaxation and contributes to better recovery.

- Design of light massage area in the middle and deep massage area on both sides.
- Durable EVA environmentally friendly material
- Length: 45cm
- Diameter: 11.5cm

ITEM LP8233



TPE YOGA MAT

TPE yoga mat with more advanced technology improvement is longer and thicker than LIVEPRO PVC model suspension mat. High-quality TPE material is light and flexible, with 1cm thickness, providing the best cushioning and support for joints. Made of non-toxic TPE material, it is more healthy to use. The textured design provides a non-slip surface for longer lasting comfort for training.

ITEM LP8227

- High-density environmental protection TPE material
- Anti-slip texture on the surface
- Designed with hanging holes
- Size: 183x61x1cm



HANGING TRAINING MAT

The hanging training mat provides a wall-mounted storage solution that saves space and keeps the field clean and organized. Simply remove from the hook and unfold when you use it. Made of EVA+PE, can be used for group training to cushion even intense exercise to avoid injuries.

ITEM LP8229

- Made of high-quality synthetic materials
- Anti-slip texture design on the surface
- Designe with hanging holes
- Size: 140x60x1.6cm



HANGING CORE MAT

LIVEPRO fitness mat offers a wall-mounted storage solution that saves space and keeps the floor clean and organized. Made of high quality PVC with anti-slip texture, the mat is lightweight, tensile, compression and impact resistant, wear-resistant and not easily deformed.

ITEM LP8220

- High-density environmental protection PVC material
- Anti-slip texture design
- Designed with hanging holes
- Size: 120x60x0.7cm



MULTI-PURPOSE STRETCHING MAT

This thickened multi-purpose stretching mat is made of PVC leather for long-lasting durability and is suitable for any workout. With a thickness of 35mm, it is light and flexible, soft and comfortable in the middle, providing support for your joints. The skin is easy to clean and can be wiped with a damp cloth.

ITEM LP8226

- 35mm thickened gravity cotton material inside
- Wear-resistant and easy to clean
- Sewing webbing puller
- Size: 140x60x3.5cm



NBR SPORTS MATS

NBR mats are more popular in the market, which is 10mm in thickness and soft, providing ultimate comfort to trainers. With better cushioning and absorption, it provides joint protection to prevent injuries; high-quality NBR has high tensile strength, is wear-resistant and not easily deformed; excellent surface adhesion and unique foam technology can effectively prevent slippage.

ITEM LP8228

- Made of high quality NBR material, it has high tensile strength
- Anti-slip texture design on the surface
- The 10mm thick mat is soft and comfortable
- Size: 185x80x1cm

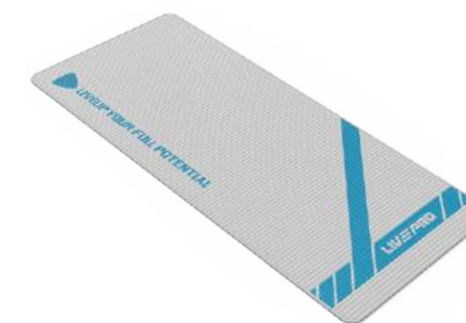



MATS HANGER

ITEM LP8821

Wall-mounted training mat hooks are designed for hanging training mats and can hold multiple training mats at a time. Wall-mounted design is used to save exercise space, and does not occupy the floor area, but also better stores training mats, which is more convenient to use.

- Made of high-quality steel with seamless welding technology
- The black frosting is sprayed on the shelf layer to increase corrosion resistance, which is not easy to rust
- Clever wall-mounted design

- **Size: 69.5L×26W×6H(cm)**
 - **Assembly required**



MATS RACK

ITEM LP8814

Training mat storage rack is designed for hanging training mats, and double-sided storage can accommodate multiple training mats at a time.

- Made of high-quality steel material
- Shelf surface is sprayed with black, which increases corrosion resistance, and is not easy to rust
- Double-sided storage design
- Directional wheels configured

- **Size: 74L×74W×207H(cm)**
 - **Assembly required**



BALL RACK

ITEM LP8858

- Made of high quality steel
- Black sprayed on the surface of the shelf increases corrosion resistance and is not easy to rust
- With triangular base, it is stable and does not move freely

- **Size: 119.8L×119.8W×149.4H(cm)**
 - **Weight: 22.9kg**
 - **Assembly required**



MULTIFUNCTIONAL STRETCH TRAINER

ITEM LP8514

Multifunctional stretch trainer can arbitrarily adjust structure which allows this product to provide the user with the support needed. A product can play the role of multiple products, and can be used to carry out mobility training which many other equipment is difficult to achieve. At the same time it provides the function of equipment such as split squat rack, hip trainer, Roman chair and so on. Mobility training is much more than flexibility training, and in addition to stretching, it provides a stable crotch fixation for a variety of training. Whether it's stability training, total body activation, or increasing the range of motion of your muscles. Its adjustable seat, removable grips, and existing and developing accessories allow this equipment to maximize the fit of your training. It fits perfectly into whatever space you have, while saving you space.

- Multifunctional stretch trainer is a combination of multiple equipment functions in one, with one product to play the role of multiple products
- Shelf surface is sprayed with black, which increases corrosion resistance, and is not easy to rust
- Seat height can be adjusted by 6 gears and the height range is 45-60cm
- Comfortable leather seats increase the experience
- The tail is equipped with two pulleys for easy movement

- Brand: Livepro
 - Color: black
 - Material: steel
 - Weight: 49kg
 - Product size: 150 × 80 × 45-60cm
 - Tube size: 7.5 × 7.5 × 0.3cm
 - Using are: 150×80cm



05

NEW FOR 2022

ENDURANCE TRAINING



COMMERCIAL LINE ROWER

ITEM LP5000

- Feature:
- With regular LCD with backlight computer " SM5878-64" -, computer Optional.
 - Multiple Display for 12 Program Profiles+4 user's memory," Time,Distance,Strokes,
 - Strokes Per Min.,Total Strokes,Pulse,500/TM,Calories,Watt,H.R.C.,Clock,Tempera-
 - ture,Recovery.
 - Magnetic control +wind resistance system , with 9V transformer .
 - Webbing + spring box construction
 - With 16-step tension control system.
 - Container loading: 62pcs / 20' FCL, 132pcs / 40' FCL, 134pcs / 40' HQ
 - Carton Size A: 1070x460x1030 mm Carton Size B: 1570x110x220 mm
 - Set up size: 2340x520x950 mm
 - Net Weight: 55 KGS, Gross Weight: 60KGS
 - Max user weight: 150kgs



WATER ROWING MACHINE

ITEM LP5001

- Feature:
- With regular LCD with backlight computer " ST3625-64" -, computer Optional.
 - Multiple Display : TIME,cALORIES,cOUNT,TOTALCNT,DISTANCE,pULES .
 - Water power system .
 - Tank material polycarbonate material .
 - The material of the slurry sheet is PE with high strength .
 - The sliding rail contains PU roller, good toughness and smooth sliding
 - The webbing wheel bearing is TPI imported from Taiwan
 - Container loading: 62pcs / 20' FCL, 132pcs / 40' FCL, 134pcs / 40' HQ
 - Carton Size A: 1150x640x820 mm Carton Size B: 1320x100x140 mm
 - Set up size: 2300x580x620 mm
 - Net Weight: 42 KGS, Gross Weight: 50KGS
 - Max user weight: 150kgs



COMMERCIAL LINE AIR-BIKE

ITEM LP5002

- Feature:
- With regular two LCD With backlight computer "ST8220-64"-, computer Optional.
 - Multiple Display "Speed" ,"Rpm", "Time", "Distance" "Recovery" function.
 - Wind resistance control system, w/o transformer.
 - Chain Structure.
 - Fan Dimensions:26 inch.
 - The resistances depend on the speed of the stampedes.
 - Container loading: 68pcs / 20' FCL, 146pcs / 40' FCL, 164pcs / 40' HQ
 - Carton Size: 1300x305x1450 mm
 - Set up size: 1300x610x1200 mm
 - Net Weight: 50KGS, Gross Weight: 56KGS
 - Max user weight: 150kgs



06

NEW FOR 2022

BOXING

www.livepro-fitness.com



BOXING GLOVES

Durable boxing gloves with Velcro, is perfect for sparring or fitness workouts. The surface is made of leather, and the interior of the leather is filled with durable and comfortable EPE cotton and in the bend of the finger, it is filled with 1cm diameter cylindrical cotton, which is more effective protection of all parts of the finger. Beautiful slogan and tear effect pattern is engraved on the back, with palm opening design, which is comfortable to wear and fit. There are three colors, representing three different sizes, for easy access.

- Made of high-quality PU leather is waterproof, wear-resistant and impact-resistant
- The leather is filled with thick EPE cotton
- Available in blue, white and red for three different sizes

ITEM LP8600-10



ITEM LP8600-12



ITEM LP8600-14



Item	Color	weight
LP8600-10		10OZ
LP8600-12		12OZ
LP8600-14		14OZ

BOXER HAND TARGET

LIVEPRO hand target is made of durable leather, which is resistant to blows, and durable. The curved design is ergonomic and fits the hands, bringing users a comfortable experience.

ITEM LP8604

- The back is high-quality PU material, which is wear-resistant and anti-tear and has strong resistance to beating
- The middle EPE cotton thickened is 5cm, which is effective to disperse the impact



BOXING FOOT TARGET

This is a product designed specifically for boxing training, with high-quality durable PVC material, which is waterproof and wear-resistant and comfortable to the touch. It is filled with environmental protection EPE material in the middle with strong cushioning force and high shock resistance, which plays a good protection role in the training of the foot and maximizes the comfort and balance, which is suitable for boxing training, etc.

ITEM LP8603

- The back is high-quality PU material, which is wear-resistant and anti-tear, and has high impact resistance
- PU material is breathable, dry and comfortable to wear
- The middle EPE cotton thickened is 11cm, which effectively disperses the impact



LIVEPRO AQUA BOXING BAG

Livepro aqua boxing bag is the ideal training equipment for every boxer. The water bag made of PVC material is filled with water which better imitates the human touch than sand bags, and can automatically return to elasticity for more natural exercises. In addition, the water bag filled with water can better absorb fist strikes, and effectively protect the hand joints in the intense training.

ITEM LP8606

- The water bag imitates the real touch of the human body and can restore the elastic structure during training, allowing for a more natural practice
- Water bag filled with water can more effectively absorb the force of fist strikes and better protect the joints of the hand
- High-quality PVC material is durable and anti-aging, has strong bending strength and impact toughness, and is resistant to hitting

- Include:
- Aqua Punching Bag
 - Shackle
 - Hose-Filling Nozzle
 - Extra Stopper

- Specifications:
- Filled Weight: 40 kgs.
 - Size: 58x45 (cm)



PUNCHING BAG

Boxing sandbag made of thickened high-quality PVC fabric can enhance the hitting resistance, the internal is uniformly filled with cotton rubber particles. Double rows of sewing thread are reinforced on the sandbag to ensure its high quality and safety, which is very suitable for use in gyms.

ITEM LP8602

- Filled with cotton inserted rubber particles
- Made of thickened PVC material
- Thicker double-row stitching, is solid and safer
- Sturdy and durable structure

- Weight: 45kg
- Size:150L×35W×35H(cm).



BOXING STAND

- Hard to deformation
- The bottom can be filled with water to add weight
- More silent hit
- Hit position marked

- Weight: 15kg
- Size: 70×180cm
- Material: PVC/EPE/HDPE



ITEM LP8607

BOXING TARGET

- High-density plastic base that can be filled with water to add weight for maximum stability
- Top PU shock-absorbing ball is for long-lasting durability
- Adjust the corresponding height between 160-220cm

- Weight: 11kg
- Size: 50×160-220cm
- Material: PE/Steel



ITEM LP8608



BOXING



BOXING BAG HOOK

- Made of pure steel
- strong and sturdy
- Safe and reliable
- 360 degree omnidirectional rotation

ITEM LP8623



BOXING BAG HOOK

The triangular bracket design is safe and stable, and effectively cushions the shock. Double-layer welding, firm and safe.

ITEM LP8622

- Size:82.2Lx102.05Wx51.64H(cm).



LIVEPRO BAG RACK

Comprehensive solution for multiplayer boxing training
Greatly improved space utilization
Can be customized freely according to the size of the venue
Can hold 6 people for boxing training at the same time

ITEM LP6300

- Mat:steel
- Tube size:80x80x3mm
- Product Size:369x195x250cm

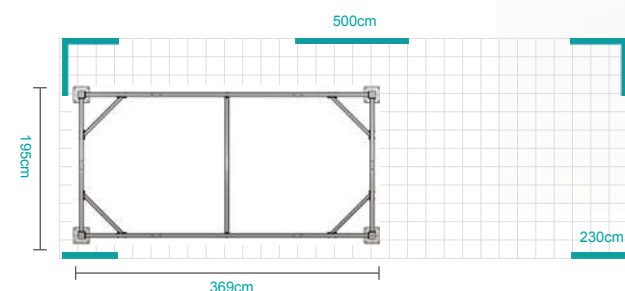
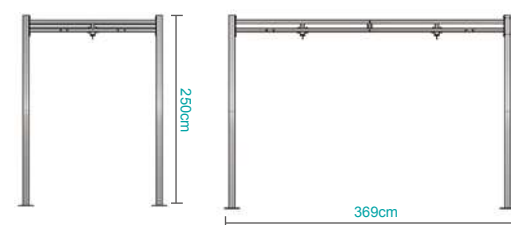

FUNCTIONAL OCCUPANCY
6
USERS

LIVEPRO BAG RACK

Used with boxing sandbags and water bags. Used for striking strength training.
When you are troubled that there is no place to hang sandbags and water bags in the venue, this shelf solves this problem well
Can accommodate three people for boxing training at the same time
The frame is made of pure steel, strong and durable, the bottom triangle structure, can maintain stability during training.

ITEM LP6301

- Mat:steel
- Tube size:100x200x4mm
- 100x100x3mm
- Product Size:370x100x261cm

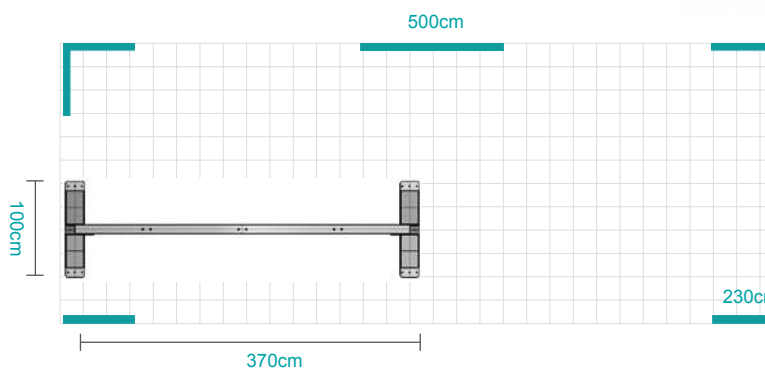
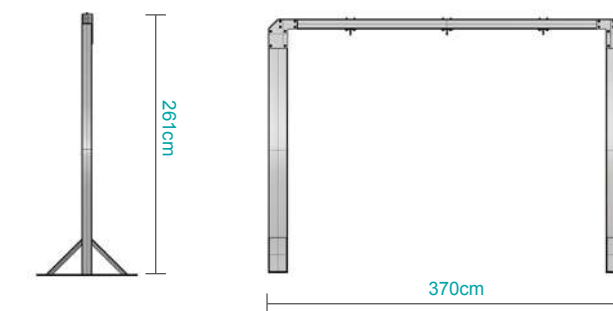

FUNCTIONAL OCCUPANCY
3
USERS



Unique 'Trolley Bag Rack' System allows easy movement of heavy bags. The wall mount version is ideal for opening up mat space and adding functionality to your gym. Heavy duty and built to last. Powder coated industrial steel. Mount to wood or masonry walls.

CUSTOMIZATION :

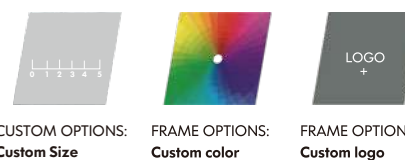

WALL MOUNT TROLLEY RACK

ITEM LP6302A

- »Mat:Q235
- »Tube Size:50x50x3mm
- Size of equipment : **767.2x367.2x98.5cm**

ITEM LP6302B

- »Mat:Q235
- »Tube Size:50x80x3mm
- Size of equipment : **603x99.1x98.5cm**



The Standing Bag Rack is a professional grade heavy bag station for your gym that is built to withstand big kicks and hard hits. As a floor mounted rack, it is also especially well-suited for gyms and studios that cannot mount bag racks to the walls. It's base comes with anchors to mount it directly into concrete subfloors, leaving the function and finish of your walls and ceilings protected while also minimizing use related noise.

CUSTOMIZATION :

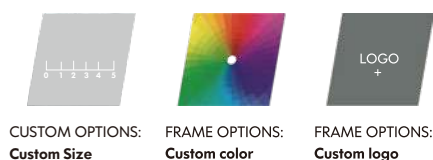

CUSTOM OPTIONS: Custom Size
FRAME OPTIONS: Custom color
FRAME OPTIONS: Custom logo

FLOOR MOUNT

ITEM LP6302C

»Mat:Q235
»Tube Size:100×100×2.5mm
50×80×3mm

Size of equipment :
605×104.1×251.1cm



Mount your Bag Trolley System directly to your ceiling to eliminate obstruction and maximize your open mat space. Add sections to seamlessly move and lock your bags anywhere along the track. Bags easily slide and lock anywhere along the heavy-duty beam rail. Add as many Bag Trolleys as you'd like.

CUSTOMIZATION :

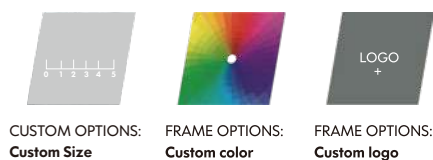

CUSTOM OPTIONS: Custom Size
FRAME OPTIONS: Custom color
FRAME OPTIONS: Custom logo

CEILING MOUNT

ITEM LP6302D

»Mat:Q235
Size of equipment :
603×99.1×98.5cm

ITEM LP6302E

»Mat:Q235
Size of equipment :
601.2×25×42.5cm

07

NEW FOR 2022

YOGA PILATES

www.livepro-fitness.com



STRETCHING/CONTOURING/BALANCING/STRENGTHENING TOOL

ITEM LP8265

- It effectively improves poor body shape, increases muscle endurance, enhances body shape, balances muscle fatigue, and increases stability
- It combines the curved shape of the dolphin and the structure of the human spine bone to complement the natural curve of the spine
- The bump design on the back of the spine corrector increases the massage function and promotes recovery

- Material: PU
- Weight: 1.1kg
- Measurement: S/M/L
- Size: 61×25×17cm



PILATES ARC

ITEM LP8267

The shape of the orthosis has soft and steep curved sides and is a versatile training tool for arms and shoulders, spine and lower back, and legs and feet. The ergonomic design is suitable for most body types.

- Helps to open the back and correct the alignment of the spine
- By removing the detachable wedge, you can simply flip the arc over and use it for balance training
- Material: EPP
- Size: 98×36.5×26.5cm



SUSPENSION TRAINING SET

ITEM LP8169

The suspension training set collects suspension trainers and wooden rings, etc. It is more challenging than just rings and suspension trainers. It can be quickly converted from single anchor training mode to double anchor training mode and from strength training to balance training to improve the versatility of the exercise.

- Designed with a double suspension
- Natural birch wood material
- Rubber cotton handle is comfortable and easy to grip



08

NEW FOR 2022

FLOORING



FLOORING

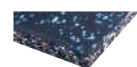

FEATURES	LP8270	LP8271	LP8272	LP8284	LP8273
USE	Free weight zone, power equipment zone, CrossFit zone.	Aerobic group exercise room, CrossFit area, home fitness, office fitness, free weight area, group training area, judo, wrestling, boxing and other areas.	Private education area, aerobic equipment area, office fitness and other areas.	Group training area, functional training area, aerobic equipment area, aerobic group exercise room	Private education area, aerobic equipment area
THICKNESS	1.5/2.0/2.5/3.0 3.5/4.0/5.0cm	5-13mm	3-12mm	5-12mm 5-13mm	0.5-1.3cm
PRODUCT SIZE	50×50cm 100×100cm	50×50cm 100×100cm	1m×Any length 50×50cm	1m×Any length 50×50cm	1m×Any length
MATERIALS	SBR and EPDM	SBR and NBR	SBR and EPDM	TPE	SBR and EPDM
RECOMMENDED INSTALLATION	DIY or professional install	DIY or professional install	DIY or professional install	DIY or professional install	DIY or professional install

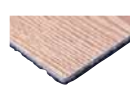

FEATURES	LP8380	LP8274	LP8275	LP8276	LP8279
USE	Strength equipment area, group training area, aerobic equipment area, aerobic group exercise room, functional training area, private education area	Yoga room, aerobic exercise room.	Karate area, martial arts, gymnastics, fitness area for children, taekwondo area.	Taekwondo area, martial arts, gymnastics, fitness area for children.	Judo, fighting wrestling, MMA, BJJ, martial arts, jujitsu and other areas.
THICKNESS	0.8/1.0cm	(2+3)mm (3+3)mm	2cm	2.0/2.5/3.0/4.0/5.0	4.0/5.0cm
PRODUCT SIZE	50×50cm	45.72×91.44cm, 45.72×45.72cm 91.44×10.16cm, 91.44×15.24cm	1×1m	1×1m	1×1m 1×2m
MATERIALS	TPE	SBR and PVC	XPE	EVA	PVC + PU/PE FOAM+ RUBBER
RECOMMENDED INSTALLATION	DIY	DIY or professional install	DIY or professional install	DIY or professional install	DIY or professional install



FEATURES	LP8277	LP8278	LP8281	LP8280	LP8282
USE	Judo, wrestling, boxing, yoga room and other areas.	Martial arts, gymnastics, children's fitness, taekwondo, karate and other areas.	Functional training area, private education area, CrossFit area, etc.	Functional training area, private education area, CrossFit area, etc.	Functional training area, private education area, CrossFit area, etc.
THICKNESS	2.5/3.0/3.5/4.0/5.0cm	2.5/3.0/3.5/4.0/5.0cm	1.6cm	1.6/2.5/3.5cm	1.6cm
PRODUCT SIZE	0-30m×1.5m 0-30m×1.8m	0-30m×1.8m	2×10m (customizable)	customizable	3×10m (customizable)
MATERIALS	PVC + XPE FOAM	Carpet + XPE foam	PE+PP	PE+PP	PE+PP
RECOMMENDED INSTALLATION	DIY or professional install	DIY or professional install	DIY or professional install	DIY or professional install	DIY or professional install



FLOORING

FLECKS MAT

Functions:

- › Suitable for home fitness, office fitness, group training, personal training area, functional training, CrossFit, strength equipment, cardio equipment, cardio group exercise room, etc.

Boxing sandbag made of thickened high-quality PVC fabric can enhance the hitting resistance, the internal is uniformly filled with cotton rubber particles. Double rows of sewing thread are reinforced on the sandbag to ensure its high quality and safety, which is very suitable for use in gyms.

- ›Material: SBR+EPDM
- ›Determination of heavy metal:qualified
- ›Flame retardant test of SGS:qualified

Item	Des	Dimension	Thickensses	DENISTY
LP8272-R	Flecks Rolls	1m × any length you specify	3-12mm	12kg/mm/m ²
LP8272-T	Flecks Tiles	50 × 50cm	3-12mm	12kg/mm/m ²
LP8272-I	Flecks Interlock	50 × 50cm	3-12mm	12kg/mm/m ²

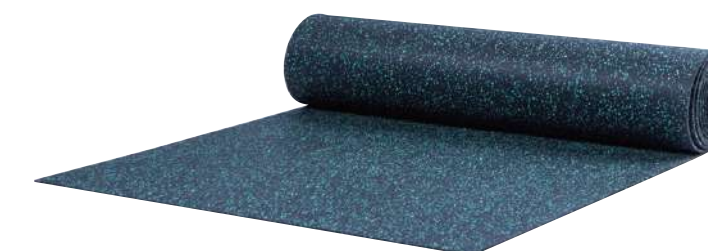

ITEM LP8272

FLECKS TILES

Areas: private parish, aerobic equipment area, office fitness area, etc.

ITEM LP8272-T

- Shock absorption, wear resistance, anti - slip, flame retardant, easy to clean, anti static, easy to install.
- A variety of specifications available.



FLECKS INTERLOCK

Areas: private parish, aerobic equipment area, office fitness area, etc.

ITEM LP8272-I

- Shock absorption, wear resistance, anti - slip, flame retardant, easy to clean, anti static, easy to install.
- A variety of specifications available.

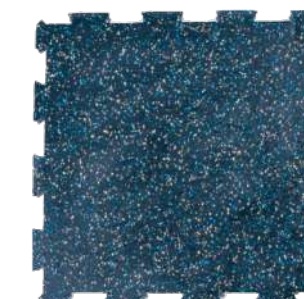

ULTRAVIOLET LED LNKJET PRINTER

UV printer is a high-tech full-color digital printing machine without plate making.It is not restricted by materials. Color photo-level printing can be performed on various floor tiles and floor mats such as rolls, composites, laminations, and locks.UV ink is imported UV ink, sprayed and dried, and the printing fastness is good. Reliable technical guarantees have been obtained for the technical difficulties of printhead control, weak solvent ink printing control, color fixation strength, and media transmission accuracy.The UV printed pattern is beautiful and wear-resistant, sound-absorbing and shock-absorbing, non-slip and heavy-resistant.Customizable sizes and patterns.It is suitable for private teaching area and group courses. The unique multi-functional training area is extremely attractive and fun, which can improve physical fitness, agility, coordination, creativity and athletic performance.

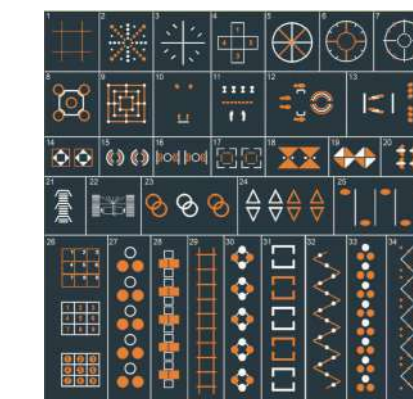

ITEM LP8273



GROUP WORKOUT MAT

The groundbreaking optimised friction technology incorporated into flooring helps avoid slipping or blocking, giving excellent levels of grip for all kinds of training. Designed for comfort, the highest quality virgin rubber gives MOTION high mobility, offering a sensational barefoot training experience while still maintaining optimum damage resistance.

»Material: TPE

AVAILABLE IN SIX COLOURS.



Item	Des	Dimension	Thickensses	DENISTY
LP8281-R	Rolls	1m x any length you specify	5-12mm	12kg/mm/m ²
LP8281-T	Tiles	50 x 50cm	5-13mm	12kg/mm/m ²
LP8281-I	Interlock	50 x 50cm	5-13mm	12kg/mm/m ²



ITEM LP8284

HIGH IMPACT TILE

The heterogeneous (dual layer) construction of the tile is a recycled rubber base bonded to a 3mm EPDM top sheet. The base layer provides sound, impact and vibration reduction. The top sheet layer provides a dense, smooth, hard wearing surface. Together they make up an effective and functional free weight gym tile.

Force Reduction

Force reduction is one of the most important factors when buying free weight flooring. The High Impact Tiles have a force reduction of 51.7% in accordance to European standards (EN14809: 2005). This means the tiles will absorb impact ensuring a safe lifting environment.

Sound and Vibration Reduction

Free weight and Olympic lifting areas are often subject to persistent impact. The flooring must minimise sound and vibration to minimise disruption to surrounding areas. The Origin tiles feature these properties.

»Material: SBR+EPDM particles
 »Determination of heavy metal:qualified
 »Flame retardant test of SGS:qualified

Dimension	Thickness	Weight	Dimension	Thickness	Weight	Dimension	Thickness	Weight
50 x 50 cm Flat	1.5cm	14.36kg/m ²	50 x 50 cm Groove	3.5cm	28.06kg/m ²	100 x 100 cm Groove	2.0cm	17.56kg/m ²
50 x 50 cm Flat	2.0cm	19.2kg/m ²	50 x 50 cm Groove	4.0cm	33.2kg/m ²	100 x 100 cm Groove	2.5cm	19.56kg/m ²
50 x 50 cm Groove	2.5cm	19.36kg/m ²	50 x 50 cm Groove	5.0cm	40.36kg/m ²	100 x 100 cm Groove	3.0cm	23.56kg/m ²
50 x 50 cm Groove	3.0cm	23.56kg/m ²	100 x 100 cm Flat	1.5cm	14.56kg/m ²			



ITEM LP8270

SBR+NBR TILE

The heterogeneous (dual layer) construction of the tile is a recycled nbr base bonded to a 3mm EPDM top sheet. The base layer provides sound, impact and vibration reduction. The top sheet layer provides a dense, smooth, hard wearing surface. Together they make up an effective and functional free weight gym tile.

Force Reduction

Force reduction is one of the most important factors when buying free weight flooring. The Origin High Impact Tiles have a force reduction of 51.7% in accordance to European standards (EN14809: 2005). This means the tiles will absorb impact ensuring a safe lifting environment.

Sound and Vibration Reduction

Free weight and Olympic lifting areas are often subject to persistent impact. The flooring must minimise sound and vibration to minimise disruption to surrounding areas. The Origin tiles feature these properties.

»Material: SBR+NBR particles
 »Determination of heavy metal:qualified
 »Flame retardant test of SGS:qualified

Dimension	Thickness	Weight	Dimension	Thickness	Weight	Dimension	Thickness	Weight
50 x 50 cm	1cm	8kg/m ²	50 x 50 cm	1.5cm	11.5kg/m ²	50 x 50 cm	2.0cm	15kg/m ²
100 x 100 cm	1cm	8kg/m ²	100 x 100 cm	1.5cm	11.5kg/m ²	100 x 100 cm	2.0cm	15kg/m ²

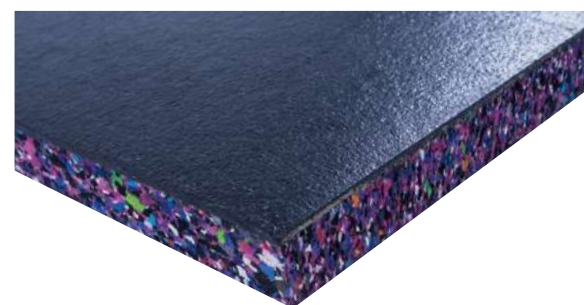

ITEM LP8271



XPE PUZZLE MAT

Livepro Puzzle Mats are an inter-locking mat system that is a quick, easy, and economical way to mat your entire training space. Cut from an extra durable, dual density XPE, each 1m x 1m puzzle mat is double-side (one color on one side, and another on the other), comes with two border strips, and is waterproof.

The Puzzle Mat is designed specifically for MMA, Jiu-Jitsu, Judo, Aikido and Hapkido, and striking arts schools that incorporate grappling into their curriculum. The dual density foam provides a safe and comfortable surface for throws and takedowns and has a light tatami surface (rice straw texture) .

CAN BE MATCHED WITH TWO COLORS.



	Dimension	Thickness	Denisty	Hardness
XPE Puzzle mat	1m×1m	20mm	110KG/CBM	47-52 SHORE C
WKF+TATAMIX certification	1m×1m	20mm	110 KG/CBM	47-52 SHORE C

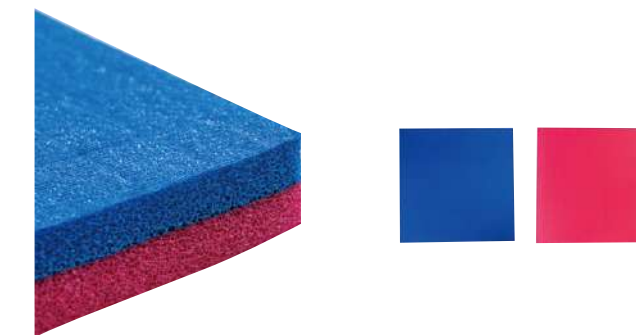

ITEM LP8275

EVA PUZZLE MAT

Livepro Puzzle Mats are an inter-locking mat system that is a quick, easy, and economical way to mat your entire training space. Cut from an extra durable, dual density XPE, each 1m x 1m puzzle mat is double-side (one color on one side, and another on the other), comes with two border strips, and is waterproof.

The Puzzle Mat is designed specifically for MMA, Jiu-Jitsu, Judo, Aikido and Hapkido, and striking arts schools that incorporate grappling into their curriculum. The dual density foam provides a safe and comfortable surface for throws and takedowns and has a light tatami surface (rice straw texture) .

CAN BE MATCHED WITH TWO COLORS.



	Dimension	Thickness	Denisty	Hardness
Puzzle mat	1m×1m	20mm	80KG/CBM	36-40 SHORE C
Puzzle mat	1m×1m	20mm	90 KG/CBM	40-45 SHORE C
Puzzle mat	1m×1m	20mm	120 KG/CBM	45-50 SHORE C
Puzzle mat	1m×1m	25mm	80 KG/CBM	36-40 SHORE C
Puzzle mat	1m×1m	25mm	90 KG/CBM	40-45 SHORE C
Puzzle mat	1m×1m	25mm	120 KG/CBM	45-50 SHORE C

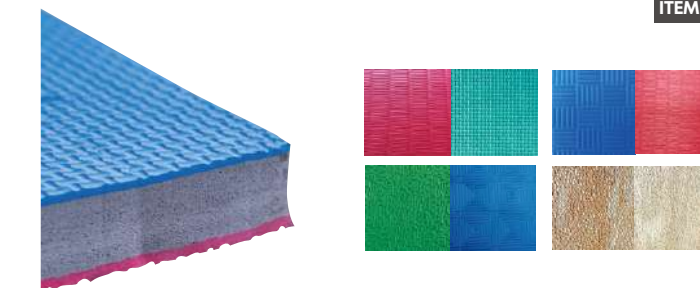

ITEM LP8276

	Dimension	Thickness	Denisty	Hardness
Puzzle mat	1m×1m	30mm	90 KG/CBM	40-45 SHORE C
Puzzle mat	1m×1m	30mm	120 KG/CBM	45-50 SHORE C
Puzzle mat	1m×1m	40mm	105 KG/CBM	43-48 SHORE C
Puzzle mat	1m×1m	40mm	120 KG/CBM	45-50 SHORE C
Puzzle mat	1m×1m	50mm	120 KG/CBM	45-50 SHORE C
Motoo WT certification	1m×1m	25mm	120 KG/CBM	45-50 SHORE C

JUDO&MMA MAT

Featuring the ultimate protection from high falls, slams, and throws, the Mat is the undisputed champion of mats. each mat is firm enough for stand-up martial arts while the need for subflooring is minimal, if not eliminated. This mat is especially popular among professional MMA and combat sports training centers, Jiu-Jitsu academies, and striking arts schools that incorporate grappling into their curriculum, as well as Law Enforcement training centers.

Regardless of thickness, the center of every Mat is a 100% recycled, multi-density, open-cell foam held together with a proprietary adhesive process.

Because the foam is open-cell, it is also completely climate stable – meaning your mats will not expand or contract with changes in temperature, additionally they reduce noise pollution, and act as an insulator which can reduce utility costs.

AVAILABLE IN SIX COLOURS.



	Dimension	Thickness	Denisty
Judo&mma mat	1m×1m	40mm	240KG/CBM
Judo&mma mat	1m×1m	50mm	240KG/CBM
Judo&mma mat	1m×2m	40mm	190KG/CBM
Judo&mma mat	1m×2m	40mm	240KG/CBM
Judo&mma mat	1m×2m	50mm	190KG/CBM
Judo&mma mat	1m×2m	50mm	240KG/CBM



ITEM LP8279



INTERLOCK MAT

The product uses environmentally friendly polymer materials and is injection molded at a time. The product has passed RoHS2.0, SGS and national body testing certification, and is the first choice for commercial and household flooring materials. The thickness of the mat is 8mm, 10mm, and a size of 50x50cm. It is easy to assemble, transport, and shape to meet the needs of general fitness areas. The floor mat adopts a snap-in type and is closely connected to avoid loose sliding and affect the sense of movement. The groove on the back can reduce vibration and noise, and can also take away the moisture on the ground to keep the ground dry for a long time. The surface adopts advanced dermatoglyphics and a matte surface, which increases the friction coefficient and reduces the chance of slipping and injury during sports. In the use of color, a variety of colors can meet various requirements and create a unique fitness floor style. The high-density surface is waterproof and non-slip, and can be cleaned at will. After washing, it is as clean as new.

ITEM LP8380



- Material: TPE
- Determination of heavy metal: qualified
- Flame retardant test of SGS: qualified

AVAILABLE IN SEVEN COLOURS.



Item	Dimension	Thickness	Weight
LP8380	50 × 50cm	0.8cm	7.04kg/m ²
LP8380	50 × 50cm	1.0cm	7.84kg/m ²

CIVILIZATION MAT

It is made of sound-insulating rolls (3mm/5mm) as the bottom layer and composited with wood-like PVC surface layer (2.0±0.2mm). The product has good elasticity, flexibility and comfort, and it has good vision of wood grain, noise reduction and noise reduction, and can effectively absorb 19 decibels, demonstrating the "civilized" life. Easy to lay, quick and easy to manage, it is an ideal home or commercial ground choice.

ITEM LP8274

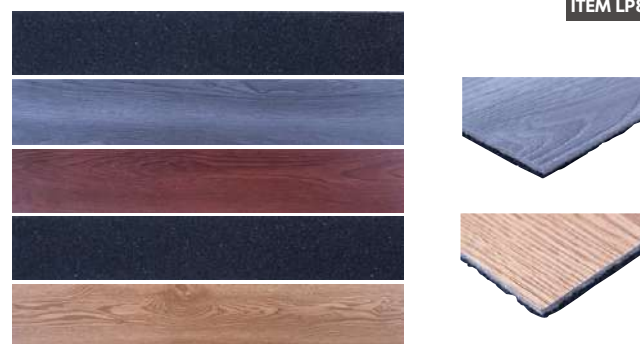

Item	Dimension	Thickness
LP8274	45.72×91.44cm	(2+3) mm
LP8274	45.72×45.72cm	(2+3) mm
LP8274	91.44×10.16cm	(3+3) mm
LP8274	91.44×15.24cm	(3+3) mm

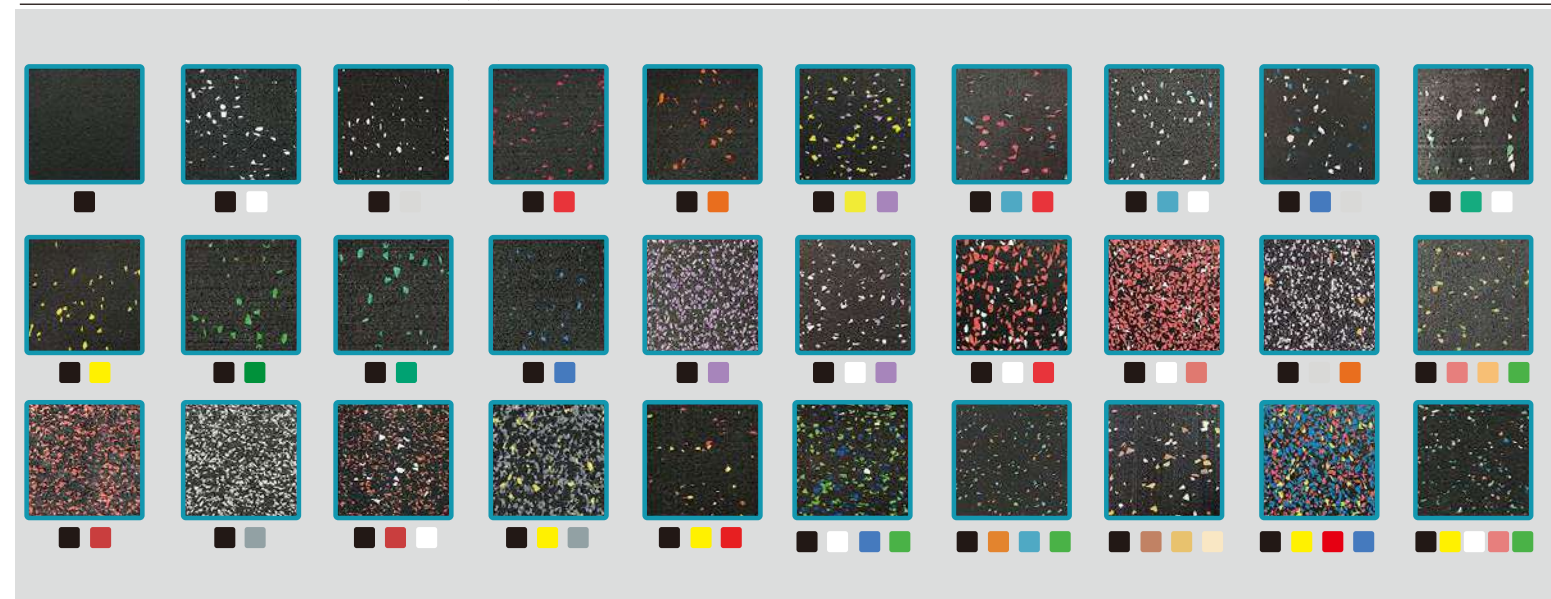

ROLL-OUT MAT

ITEM LP8277



PVC

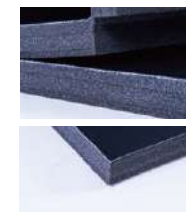

ITEM LP8278



Carpet type



Whether you're into martial arts, fitness, yoga, or a little of each, Livepro Roll-Out Mat is your go-to for a lightweight and portable training or practice space. Each roll-out mat is 1.5m width, easy to unroll and re-roll, comes with a storage strap, and features a traditional non-slip surface.

AVAILABLE IN FIVE COLOURS.



Surface	Dimension	Thickness	Density
PVC	1.5m(width)×0-30m	25mm	55±5KG/CBM
PVC	1.5m(width)×0-30m	30mm	55±5KG/CBM
PVC	1.5m(width)×0-30m	35mm	55±5KG/CBM
PVC	1.5m(width)×0-30m	40mm	55±5KG/CBM
PVC	1.5m(width)×0-30m	50mm	55±5KG/CBM
Carpet type	1.8m(width)×0-30m	25mm	65±5KG/CBM

Surface	Dimension	Thickness	Density
Carpet type	1.8m(width)×0-30m	30mm	65±5KG/CBM
Carpet type	1.8m(width)×0-30m	35mm	65±5KG/CBM
Carpet type	1.8m(width)×0-30m	40mm	65±5KG/CBM
Carpet type	1.8m(width)×0-30m	50mm	65±5KG/CBM
WT Standard	WT Standard	25mm	75±5KG/CBM
WT Standard	WT Standard	30mm	75±5KG/CBM





TRACK TURF

ITEM LP8281



TURF

ITEM LP8280



TRACK TURF-COUSTOM

ITEM LP8282



The livepro Turf will be a great asset for your gym or outdoor training area, adding something different and exposing users to a wide range of new training possibilities. This heavy-duty artificial grass has been extensively tested and designed specifically for sport and fitness applications, including the use of prowlers, drag sleds and other common fitness training tools. The combination of a short fibre and high density of the mat ensures that the mat is resistant to wear and offers very durable as a sports flooring solution.

- Features:
- »Standard available in widths of 2m and 4m.
 - »100% monofilament
 - »Extremely high density and durable product.
 - »Designed for high-performance areas.

- »Material: PE+PP
- »Acid and alkali resistance test: 48h
- »Organic resistance test: gasoline immersion 4h
- »Color fastness to weather: ≥5

AVAILABLE IN SEVEN COLOURS.



09

NEW FOR 2022

LIVEPRO GEARS





LIFTING WRIST WRAPS

- High quality polyester material
- Polyester is flexible and easily adjustable to fit all sizes
- Elastic thumb rings are designed to fix on the thumb
- Size: 33x8cm

ITEM LP8090



LIFTING STRAPS

- Made of durable polyester for being breathable as well as comfort and sturdiness
- Adjustable bracelet fits all sizes
- The booster strap is stitched with precision instruments, which is strong and wear-resistant and not easy to lose shape
- Size:56x3.8cm

ITEM LP8092



BLOOD FLOW RESTRICTION BANDS

- High-quality polyester material
- Double reinforced sewing
- Size:66x5cm

ITEM LP8096



BARBELL PAD

The barbell bar shoulder pad can effectively improve bruising and pain caused by the pressure on the shoulders and neck during barbell squats, the high-density foam liner protects the neck and back during exercise, designed for comfort. Non-deformable, and thickened design is suitable for a variety of barbell bars, and the outer layer of non-slip composite fabric (polyester outside and diving fabric inside) wrapped is comfortable, breathable, wear-resistant and used, which can be firmly fixed by Velcro.

ITEM LP8093

- Outer laminated fabric
- Shoulder pad with high-density foam lining with 9cm thickness, is comfortable to use, not easy to deformation, and fits the neck contour
- Velcro is firmly fixed after installation, which is not easy to move and easy to remove

- Size: 45x9cm



GYM CHALK

When you are in the gym or climbing and want to have a better grip, talcum powder is the best choice. It is made of natural magnesium carbonate with no additives and fillers. When you work out, using talcum powder can greatly increase the friction between your palm and the equipment, thus increasing grip strength and not causing slippery hands.

ITEM LP8190

- Spherical talcum powder is to prevent waste in use
- Equipped with storage bag is to prevent dust from flying



FITNESS GLOVES

Fitness gloves are made of high-quality lightweight microfiber, which is comfortable to wear and breathable mesh on the back of the hand can keep hands dry. The silicone print on the palm area prevents slippage and injury and allows for a quick improvement in grip strength for athletes. These gloves are not only suitable for weightlifting, but also perfect for lifting, gymnastics, kettlebells, barbells and other workouts.

ITEM LP8260

- Elastic wristband is comfortable and fit
- Silicone palm can increase hand grip and prevent injuries
- Size:
M:17x12.5cm
L:17.5x13.5cm



AB SLING

The suspension sling is made of durable polyester for strength and abrasion resistance to be used. The sling is wide enough to support most people's upper arms, so it's also a more comfortable option for larger people.

ITEM LP8164

- Heavy sewing reinforcement on the sling makes the sling stronger and more durable
- Made of durable polyester material
- Alloy steel buckle



JUMP ROPE

- Adjustable length
- Made of high-quality PVC and is lightweight material
- Black part of the handle is made of TPR material, with comfortable grip
- Handle anti-slip texture is designed, which is not only beautiful and generous, but also increases the anti-slip and is not easy to get off during exercise

ITEM LP8286



JUMP ROPE

WEIGHTED JUMP ROPE

- High-quality handle material
- With high-precision ball bearing rotating
- Beautifully engraved knurled handle is more non-slip
- Durable steel wire rope is outside wrapped with colorful coating, which is wear-resistant

ITEM LP8283

ITEM LP8283H

Desc	Item	Color	Weight
Jump Rope	LP8283		185g
	LP8283		185g
Weighted Jump Rope	LP8283-H		300g
	LP8283-H		300g



ROPE TRAINER

The Livepro rope trainer is a portable fitness stretching device that exercises the whole body. It uses a unique suction technology and a smooth surface to allow athletes to train anytime and anywhere. The rope trainer has three different types of resistance levels 2.5kg, 5kg, and 7.5 kg.

ITEM LP8408

- Adjustable resistance
- The unique suction cup technology allows it to be firmly fixed anywhere
- This trainer is very flexible, can be pulled to 1.5m, has a 360 degree angle, and any posture could be used
- The comfortable TPE material has a non-slip texture designed surface



ALUMINUM HANDLE GRIP

- High-strength springs are for precise grip training
- Aluminum handle is wear-resistant and corrosion-resistant
- Handles engraved with beautiful knurling, are beautiful and non-slip, to achieve maximum grip
- Spring with black spraying

ITEM LP8285

Item	Color	Stength
LP8285-60		60lbs
LP8285-100		100lbs
LP8285-140		140lbs
LP8285-200		200lbs
LP8285-280		280lbs



TELESCOPIC FASCIA ROLLER

A truly portable foam shaft, weighing less than 1kg and measuring only 13cm when folded, is very portable and allows you to relieve pain and speed up your recovery wherever you are. Regular use of the roller can provide benefits such as increased flexibility, improved balance and mobility, and readiness for optimal athletic performance.

ITEM LP8239

- Easy to stretch and easy to carry
- The telescopic fascia roller is made of high-strength industrial material, tested to stretch to full size and can withstand 200kg of human weight
- Each 3D massage point is made of solid soft rubber of moderate hardness
- Environmentally friendly material without odor





MUSCLE MASSAGE BALL

ITEM LP8501

It stimulates blood circulation while rolling, which can increase mobility and help recover faster from workouts or injuries. It can be carried around in a gym bag, backpack and massaged anytime, anywhere.

- Material: Polyurethane
- Diameter: 6.5cm
- Weight: 150g



MASSAGE PEANUT BALL

ITEM LP8502

The peanut ball provides a good grip and stays in place, helping to reduce muscle pain and improve mobility.

- Length: 14cm
- Diameter: 6.5cm
- Weight: 300g



WEIGHTED WRISTBAND

ITEM LP8287

It can be worn on the wrist and ankle for weight training to enhance arm resistance and increase muscle burn.

- Fashionable and beautiful
- Free to adjust the weight and tightness

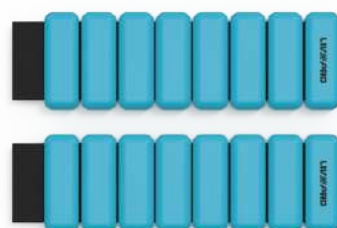

RUST REMOVER

ITEM LP9000

It is suitable for various materials including chrome, magnesium, aluminum, stainless steel lamp and other metal surfaces to restore luster.



ANTIBACTERIAL AGENT

ITEM LP9001

Antibacterial and deodorizing, it can effectively remove the mold, bacteria and odor that grow on the surface of fitness equipment, aluminum, stainless steel, carbon and plastic due to daily use.



GYM SHAKER

ITEM LP8147

Livepro Protein Drinking Cup is made of food-grade PP material, which is safe and environmentally friendly, with a built-in metal shaker ball, suitable for proteins, shakes and smoothies, etc. Shake it easily with the metal shaker ball.

- Cup has a large capacity of 600ml
- Food-grade PP material
- Sealed and splash-proof



GYM DRAWSTRING BAG

ITEM LP7000

Livepro sports backpack is made of waterproof and durable polyester fabric on the front, which can keep the backpack dry and prevent the internal items from getting wet. The two-layer mesh back fabric breathes well and is comfortable to carry.

- Backpack is 33cm in length and 46.5cm in height
- waterproof polyester fabric
- Top drawstring design
- Bottom of the bag to strengthen the protection



LIVEPRO STOOL

ITEM LP7010

Livepro stool can be used both for jump training and for sitting and resting after a workout. It is very small and delicate with internal wooden frame, as well as strong and durable.

- Stool is wooden frame inside, super load-bearing, more sturdy and durable
- There is recycled cotton sandwich between the surface PVC leather and wooden board, and it sits softly and comfortably



10

NEW FOR 2022

STORAGE SOLUTION



Customizable storage and suspension system

www.livepro-fitness.com

FUNCTIONAL OCCUPANCY
6-8
USERS



GAIN[S] is LIVEPRO's new storage solution brand. Today, the motion space has diversified dimensions and designs, but to realize the function of space utilization and exercise maximization effectively is their common goal. Equipment placement, safety and space saving are significant. Gain[S] system can keep storage while activating other systems. Gain[S] storage and suspension system adopts modular design, which is perfect for group studio, dynamic training area and private extension area.

PRODUCTS REFERENCE :

- 1. STEEL COMPETITION KETTLEBELL (X4)
- 2. 12-SIDED URETHANE DUMBBELLS (X9)
- 3. WALL BALL (X12)
- 4. PERFORMANCE ROLLER (X4)
- 5. POWER BAND (X2)
- 6. MASSAGE BALL
- 7. HANGING CORE MAT

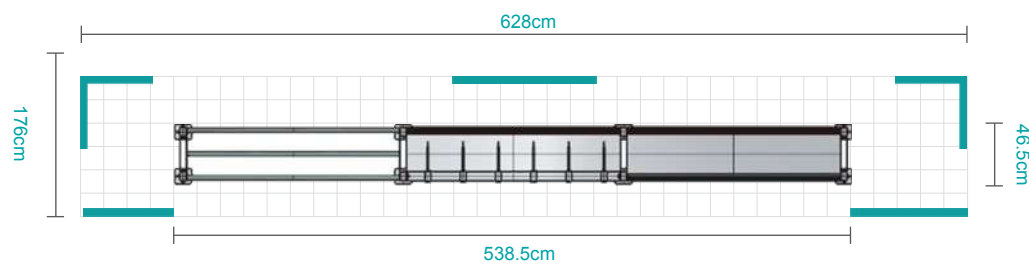

FEATURES :

- 1. Modular configuration and future expandability
- 2. Interchangeable, quick-change shelving system
- 3. Freedom mount technology
- 4. Custom color
- 5. Custom logo

CUSTOMIZATION :

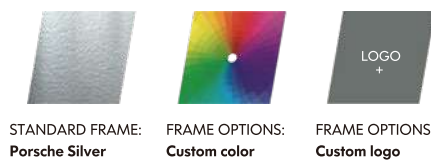

Size of equipment:
538.5x46.5x181.4cm

LP8950 STORAGE RACK

Training Area:
628x176cm

Email : sales@liveupsports.com
Phone : 0086-513-81180020

LIVEPRO
LIVEPRO HEALTH-TECH CO.,LTD



Customizable storage and suspension system

www.livepro-fitness.com

FUNCTIONAL OCCUPANCY
8-10
USERS



GAIN[S] is LIVEPRO's new storage solution brand. Today, the motion space has diversified dimensions and designs, but to realize the function of space utilization and exercise maximization effectively is their common goal. Equipment placement, safety and space saving are significant. Gain[S] system can keep storage while activating other systems. Gain[S] storage and suspension system adopts modular design, which is perfect for group studio, dynamic training area and private extension area.

PRODUCTS REFERENCE :

- 1. ANTI-BURST CORE-FIT EXERCISE BALL (X2)
- 2. WALL BALL (X9)
- 3. STEEL COMPETITION KETTLEBELL (X18)
- 4. SOLID MEDICINE BALL (X12)
- 5. 12-SIDED URETHANE DUMBBELLS (X24)

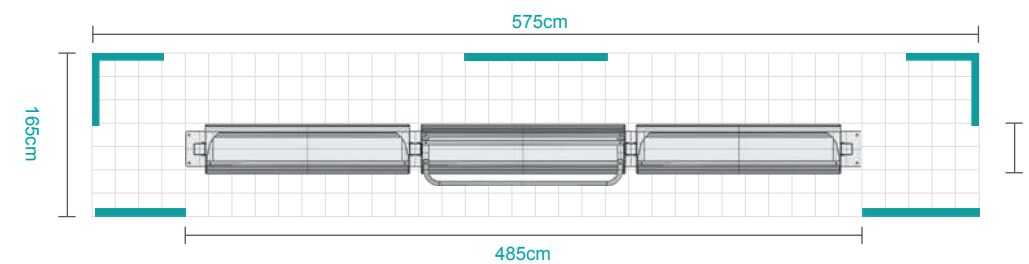

FEATURES :

- 1. Modular configuration and future expandability
- 2. Interchangeable, quick-change shelving system
- 3. Freedom mount technology
- 4. Custom color
- 5. Custom logo

CUSTOMIZATION :

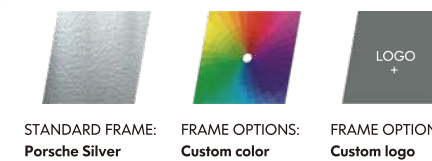

Size of equipment:
485x35.2x200cm

LP8951 STORAGE RACK

Training Area:
575x165cm

Email : sales@liveupsports.com
Phone : 0086-513-81180020

LIVEPRO
LIVEPRO HEALTH-TECH CO.,LTD



Customizable storage and suspension system

www.livepro-fitness.com

FUNCTIONAL OCCUPANCY
6-8
USERS



Customizable storage and suspension system

www.livepro-fitness.com

FUNCTIONAL OCCUPANCY
3-4
USERS

GAIN[S] is LIVEPRO's new storage solution brand. Today, the motion space has diversified dimensions and designs, but to realize the function of space utilization and exercise maximization effectively is their common goal. Equipment placement, safety and space saving are significant. Gain[S] system can keep storage while activating other systems. Gain[S] storage and suspension system adopts modular design, which is perfect for group studio, dynamic training area and private extension area.

PRODUCTS REFERENCE :

- | | |
|-------------------------------------------|--------------------------------------|
| 1. HANGING CORE MAT (X10) | 7. PERFORMANCE ROLLER (X3) |
| 2. POWER BARBELLS (X3) | 8. STEEL COMPETITION KETTLEBELL (X6) |
| 3. ANTI-BURST CORE-FIT EXERCISE BALL (X2) | 9. BULGARIAN BAG (X5) |
| 4. BALANCE PAD (X4) | 10. WALL BALL (X5) |
| 5. MASSAGE BALL | 11. POWER BAND (X2) |
| 6. SOLID MEDICINE BALL (X8) | |

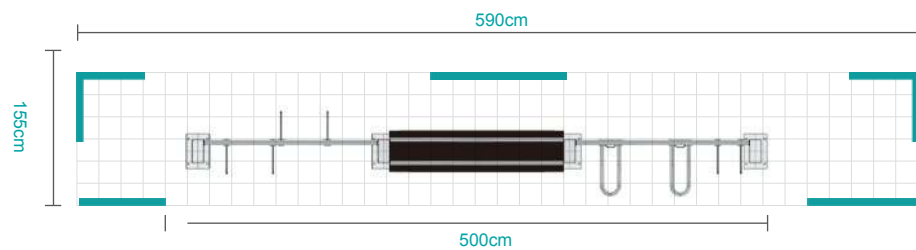
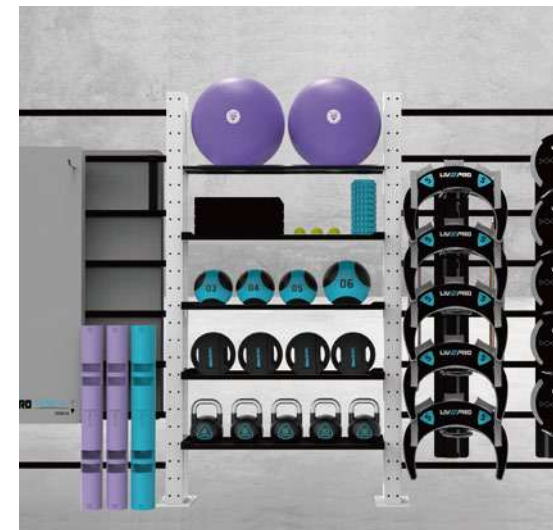

FEATURES :

1. Modular configuration and future expandability
2. Interchangeable, quick-change shelving system
3. Freedom mount technology
4. Custom color
5. Custom logo

CUSTOMIZATION :

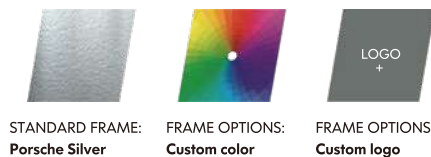

Size of equipment:
500x35x240cm

Training Area:
590x155cm

LP8952 STORAGE RACK

Email : sales@liveupsports.com
Phone : 0086-513-81180020

LIVEPRO
LIVEPRO HEALTH-TECH CO.,LTD

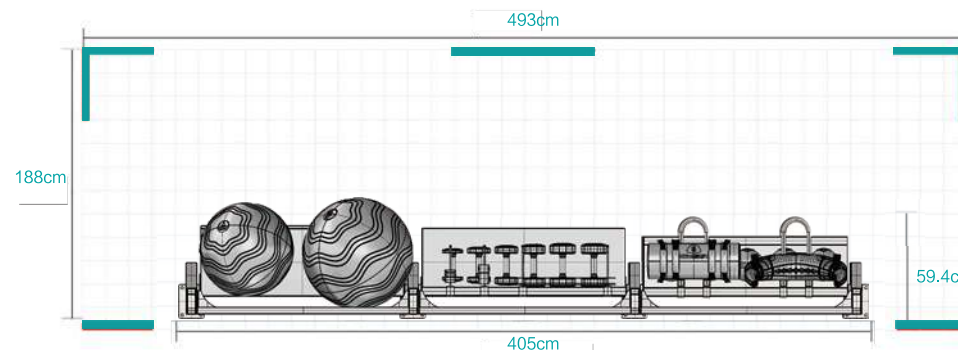

FEATURES :

1. Modular configuration and future expandability
2. Interchangeable, quick-change shelving system
3. Freedom mount technology
4. Custom color
5. Custom logo

CUSTOMIZATION :

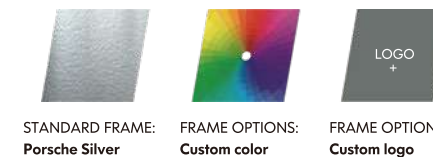

Size of equipment:
405x59.4x230cm

Training Area:
493x188cm

GS-TRS-L TRIPLE STORAGE

Email : sales@liveupsports.com
Phone : 0086-513-81180020

LIVEPRO
LIVEPRO HEALTH-TECH CO.,LTD

GAIN[S] is LIVEPRO's new storage solution brand. Today, the motion space has diversified dimensions and designs, but to realize the function of space utilization and exercise maximization effectively is their common goal. Equipment placement, safety and space saving are significant. Gain[S] system can keep storage while activating other systems. Gain[S] storage and suspension system adopts modular design, which is perfect for group studio, dynamic training area and private extension area.

PRODUCTS REFERENCE :

- | | |
|--------------------------------------|-------------------------------------------|
| 1. BULGARIAN BAG (X4) | 6. 12-SIDED URETHANE DUMBBELLS (X6) |
| 2. POWER BAG (X4) | 7. ANTI-BURST CORE-FIT EXERCISE BALL (X2) |
| 3. STEEL COMPETITION KETTLEBELL (X5) | 8. WALL BALL (X3) |
| 4. HANGING CORE MAT (X3) | 9. DOUBLE GRIP MEDICINE BALL (X5) |
| 5. POWER BAND (X1) | 10. THE BALANCE TRAINER |





Customizable storage and suspension system

www.livepro-fitness.com

FUNCTIONAL OCCUPANCY
4-6
USERS

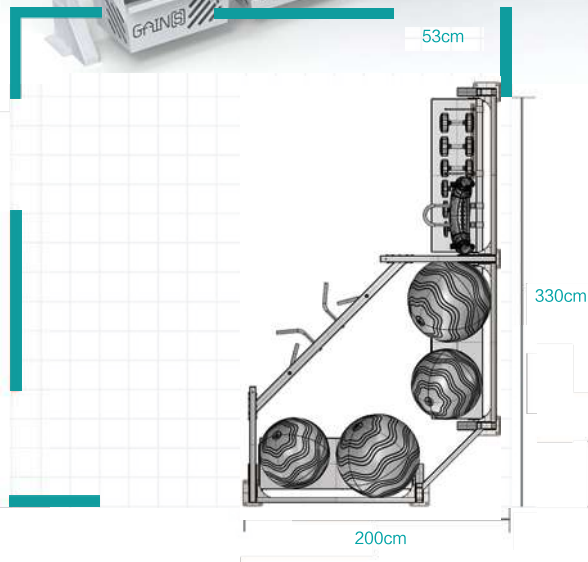

GAIN[S] is LIVEPRO's new storage solution brand. Today, the motion space has diversified dimensions and designs, but to realize the function of space utilization and exercise maximization effectively is their common goal. Equipment placement, safety and space saving are significant. Gain[S] system can keep storage while activating other systems. Gain[S] storage and suspension system adopts modular design, which is perfect for group studio, dynamic training area and private extension area.

PRODUCTS REFERENCE :

- | | |
|-------------------------------------------|-----------------------------------|
| 1. BULGARIAN BAG (X4) | 7. DOUBLE GRIP MEDICINE BALL (X5) |
| 2. 12-SIDED URETHANE DUMBBELLS (X6) | 8. SOLID MEDICINE BALL (X5) |
| 3. HANGING CORE MAT (X3) | 9. THE BALANCE TRAINER (X2) |
| 4. ANTI-BURST CORE-FIT EXERCISE BALL (X4) | 10. AGILITY DOT |
| 5. WALL BALL (X6) | 11. QUICK CONES |
| 6. STEEL COMPETITION KETTLEBELL (X5) | 12. AGILITY CONES |



FEATURES :

1. Modular configuration and future expandability
2. Interchangeable, quick-change shelving system
3. Freedom mount technology
4. Custom color
5. Custom logo

CUSTOMIZATION :

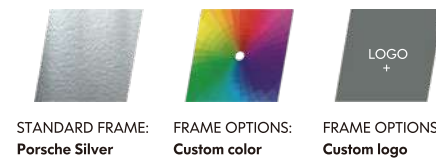

Size of equipment:
330x200x245cm

GS-FC-L FUNCTIONAL CORNER

Training Area:
561x358cm

Email : sales@liveupsports.com
Phone : 0086-513-81180020

LIVEPRO
LIVEPRO HEALTH-TECH CO.,LTD



Customizable storage and suspension system

www.livepro-fitness.com

FUNCTIONAL OCCUPANCY
12-14
USERS

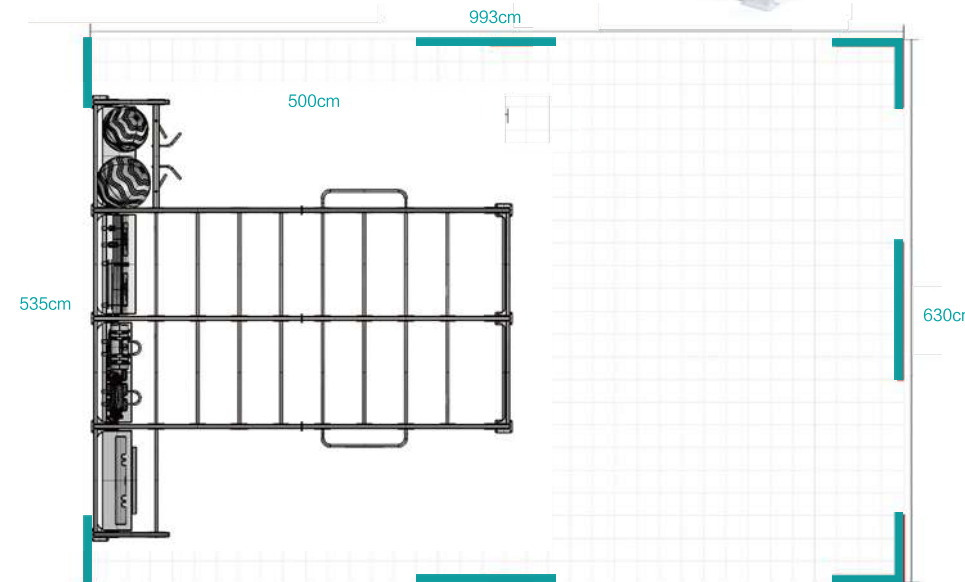
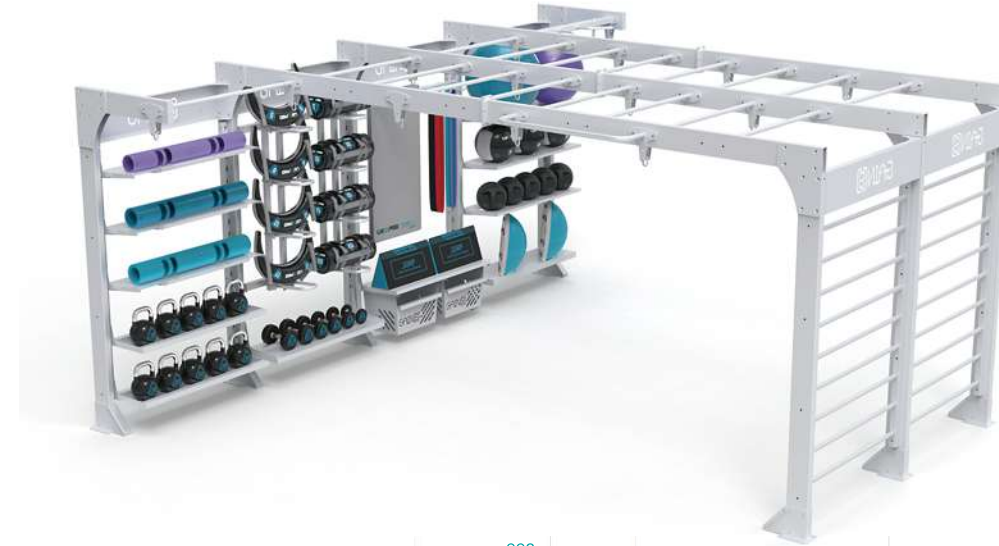

GAIN[S] is LIVEPRO's new storage solution brand. Today, the motion space has diversified dimensions and designs, but to realize the function of space utilization and exercise maximization effectively is their common goal. Equipment placement, safety and space saving are significant. Gain[S] system can keep storage while activating other systems. Gain[S] storage and suspension system adopts modular design, which is perfect for group studio, dynamic training area and private extension area.

PRODUCTS REFERENCE :

- | | |
|--------------------------------------|-------------------------------------------|
| 1. POWER BARBELLS (X3) | 7. POWER BAND SET (X1) |
| 2. STEEL COMPETITION KETTLEBELL (X1) | 8. LATERAL ENDURANCE HURDLE (X2) |
| 3. BULGARIAN BAG (X4) | 9. ANTI-BURST CORE-FIT EXERCISE BALL (X2) |
| 4. POWER BAG (X4) | 10. WALL BALL (X3) |
| 5. 12-SIDED URETHANE DUMBBELLS (X6) | 11. DOUBLE GRIP MEDICINE BALL (X5) |
| 6. HANGING CORE MAT (X3) | 12. THE BALANCE TRAINER (X2) |



FEATURES :

1. Modular configuration and future expandability
2. Interchangeable, quick-change shelving system
3. Freedom mount technology
4. Custom color
5. Custom logo

CUSTOMIZATION :

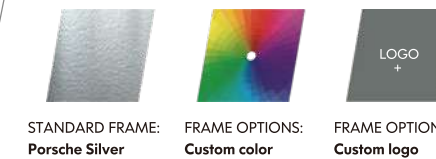

Size of equipment:
500x535x245cm

GS-TBX2 T BRIDGE

Training Area:
993x630cm

Email : sales@liveupsports.com
Phone : 0086-513-81180020

LIVEPRO
LIVEPRO HEALTH-TECH CO.,LTD



Customized storage and suspension system

www.livepro-fitness.com

FUNCTIONAL OCCUPANCY
6-8
USERS

GAIN[S] is LIVEPRO's new storage solution brand. Today, the motion space has diversified dimensions and designs, but to realize the function of space utilization and exercise maximization effectively is their common goal. Equipment placement, safety and space saving are significant. Gain[S] system can keep storage while activating other systems. Gain[S] storage and suspension system adopts modular design, which is perfect for group studio, dynamic training area and private extension area.

PRODUCTS REFERENCE :

- | | |
|-------------------------------------|---------------------------------------------------|
| 1. FOAM ROLLER (X1) | 6. WALL BALL (X3) |
| 2. POWER BAND (X2) | 7. KETTLEBELL (X4) |
| 3. HANGING CORE MAT | 8. BALANCE TRAINER (X2) |
| 4. 12-SIDED URETHANE DUMBBELLS (X6) | 9. URETHANE COMPETITION COLORED BUMPER PLATE (X6) |
| 5. DOUBLE GRIP MEDICINE BALL (X4) | 10. BARBELL SET |

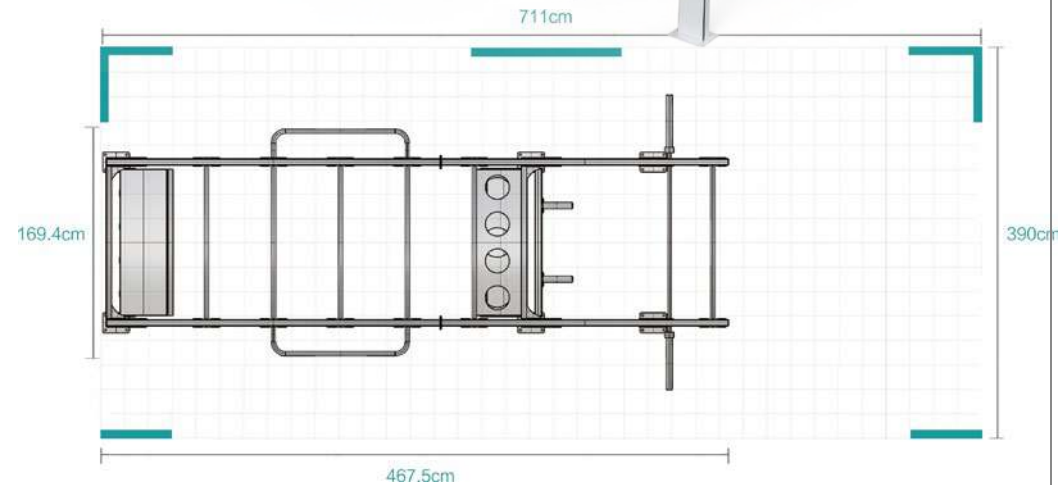
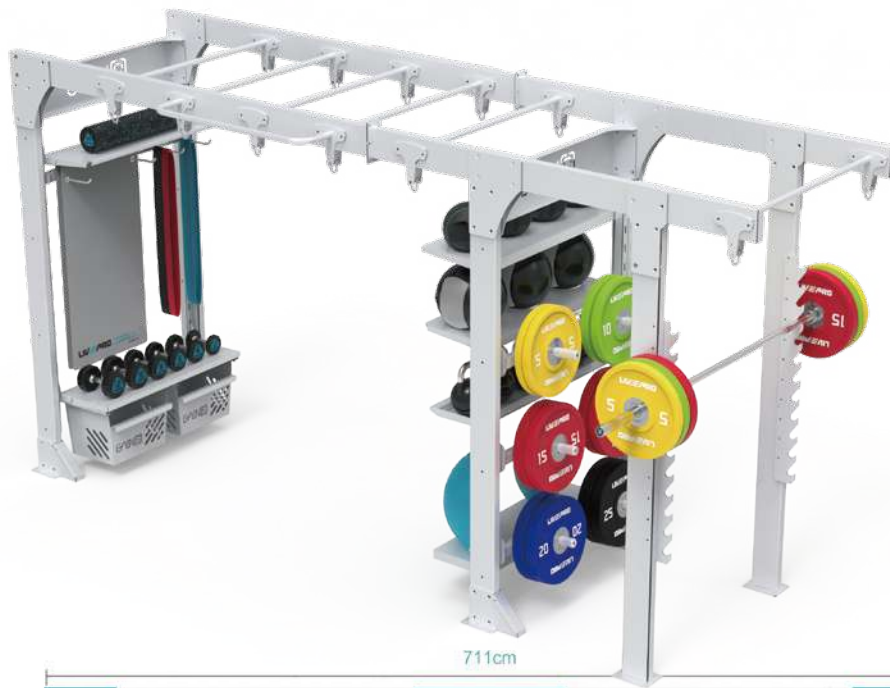

FEATURES :

1. Modular configuration and future expandability
2. Interchangeable, quick-change shelving system
3. Freedom mount technology
4. Custom color
5. Custom logo

CUSTOMIZATION :

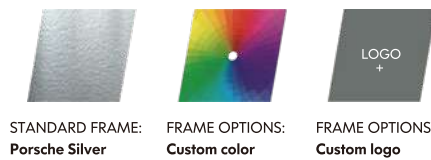

Size of equipment:
500x35x240cm

Training Area:
590x155cm

GS-SQUART-BRIDGE_S SQUART BRIDGE

Email : sales@liveupsports.com
Phone : 0086-513-81180020

LIVEPRO
LIVEPRO HEALTH-TECH CO.,LTD



Customizable storage and suspension system

www.livepro-fitness.com

FUNCTIONAL OCCUPANCY
4-6
USERS

GAIN[S] is LIVEPRO's new storage solution brand. Today, the motion space has diversified dimensions and designs, but to realize the function of space utilization and exercise maximization effectively is their common goal. Equipment placement, safety and space saving are significant. Gain[S] system can keep storage while activating other systems. Gain[S] storage and suspension system adopts modular design, which is perfect for group studio, dynamic training area and private extension area.

PRODUCTS REFERENCE :

- | | |
|---------------------------------------|----------------------------|
| 1. DOUBLE GRIP MEDICINE BALL (X4) | 6. HANGING CORE MAT |
| 2. WALL BALL (X3) | 7. PERFORMANCE ROLLER (X1) |
| 3. STEEL COMPETITION KETTLEBELL (X5) | 8. POWER BAND |
| 4. 12-SIDED URETHANE DUMBBELLS (X6) | 9. BARBELL |
| 5. URETHANE TRAINING PLATES WITH GRIP | |

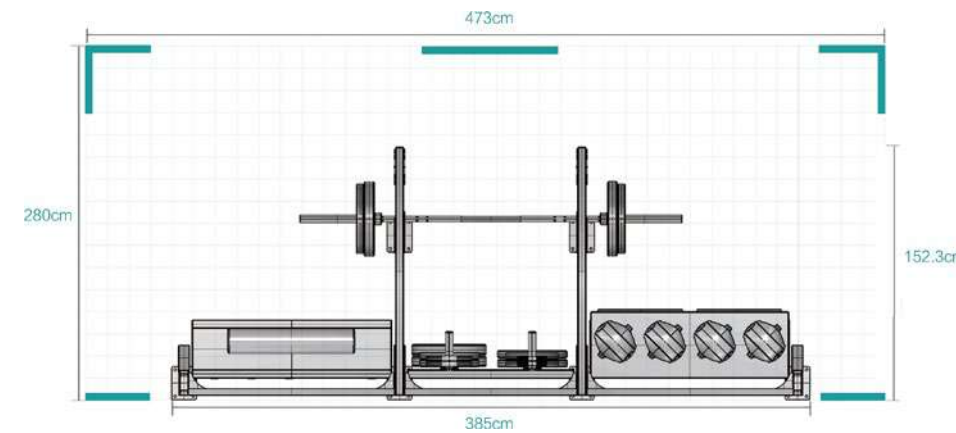

FEATURES :

1. Modular configuration and future expandability
2. Interchangeable, quick-change shelving system
3. Freedom mount technology
4. Custom color
5. Custom logo

CUSTOMIZATION :

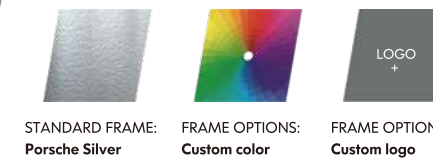

Size of equipment:
385x152.3x245cm

Training Area:
473x280cm

GS-SRS-L SQUART STORAGE

Email : sales@liveupsports.com
Phone : 0086-513-81180020

LIVEPRO
LIVEPRO HEALTH-TECH CO.,LTD



Customized storage and suspension system

www.livepro-fitness.com

FUNCTIONAL OCCUPANCY
10-12
USERS

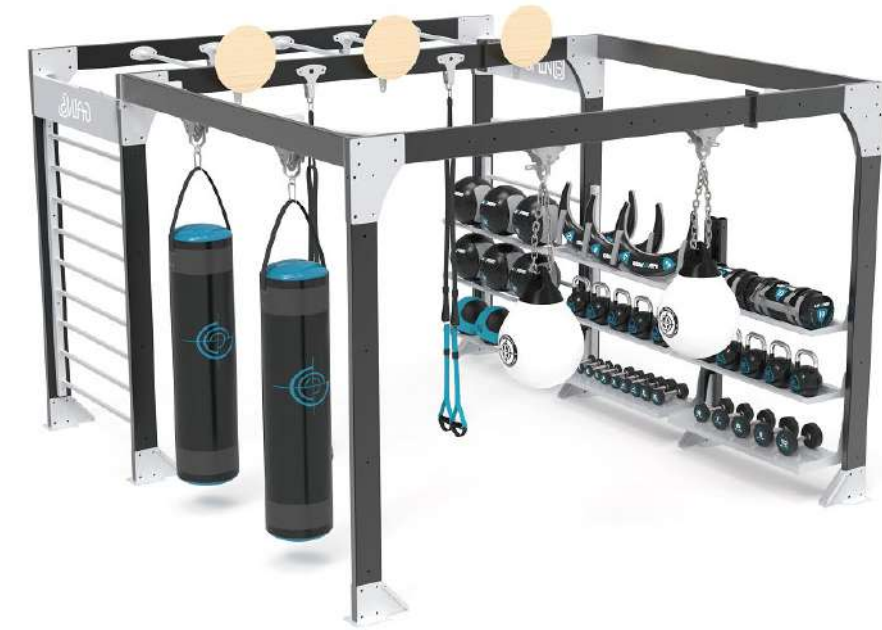

GAIN[S] is LIVEPRO's new storage solution brand. Today, the motion space has diversified dimensions and designs, but to realize the function of space utilization and exercise maximization effectively is their common goal. Equipment placement, safety and space saving are significant. Gain[S] system can keep storage while activating other systems. Gain[S] storage and suspension system adopts modular design, which is perfect for group studio, dynamic training area and private extension area.

PRODUCTS REFERENCE :

- | | |
|---------------------------------|---------------------------------|
| 1. PUNCHING BAG (X2) | 6. BULGARIAN BAG (X3) |
| 2. LIVEPRO AQUA BOXING BAG (X2) | 7. POWER BAG (X2) |
| 3. SUSPENSION TRAINER (X2) | 8. COMPETITION KETTLEBELL (X10) |
| 4. WALL BALL (X6) | 9. DUMBBELLS |
| 5. SOLID MEDICINE BALL (X3) | |

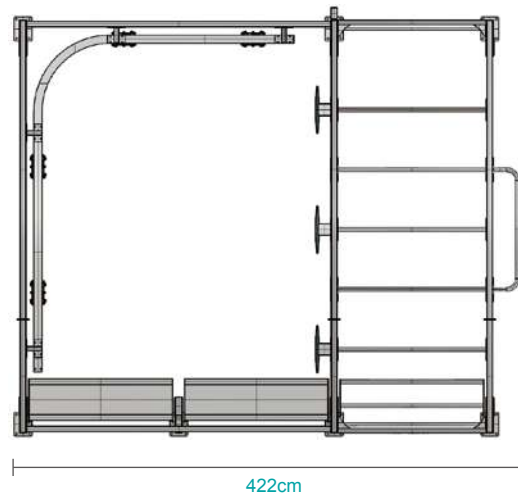

FEATURES :

1. Modular configuration and future expandability
2. Interchangeable, quick-change shelving system
3. Freedom mount technology
4. Custom color
5. Custom logo

CUSTOMIZATION :

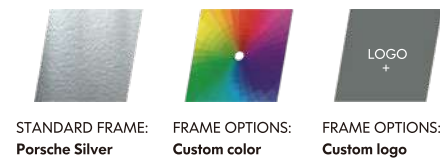

Size of equipment:
422x350x270cm

Training Area:
600x320cm

GS-TROLLEY-GROUP_1 TROLLEY BRIDGE

Email : sales@liveupsports.com
Phone : 0086-513-81180020

LIVEPRO
LIVEPRO HEALTH-TECH CO.,LTD



Customizable storage and suspension system

www.livepro-fitness.com

FUNCTIONAL OCCUPANCY
3-4
USERS



GAIN[S] is LIVEPRO's new storage solution brand. Today, the motion space has diversified dimensions and designs, but to realize the function of space utilization and exercise maximization effectively is their common goal. Equipment placement, safety and space saving are significant. Gain[S] system can keep storage while activating other systems. Gain[S] storage and suspension system adopts modular design, which is perfect for group studio, dynamic training area and private extension area.

PRODUCTS REFERENCE :

- | | |
|---------------------------------|---------------------------|
| 1. SUSPENSION BEAMS (X2) | 6. PLATE HOLDER (X1) |
| 2. PULL UP RAMP (X1) | 7. BAR HOLDER (X2) |
| 3. ROTATIONAL CORE TRAINER (X1) | 8. BAR SAFETY HOLDER (X2) |
| 4. BALL STORAGE (X2) | |
| 5. KETTLEBELL STORAGE (X1) | |

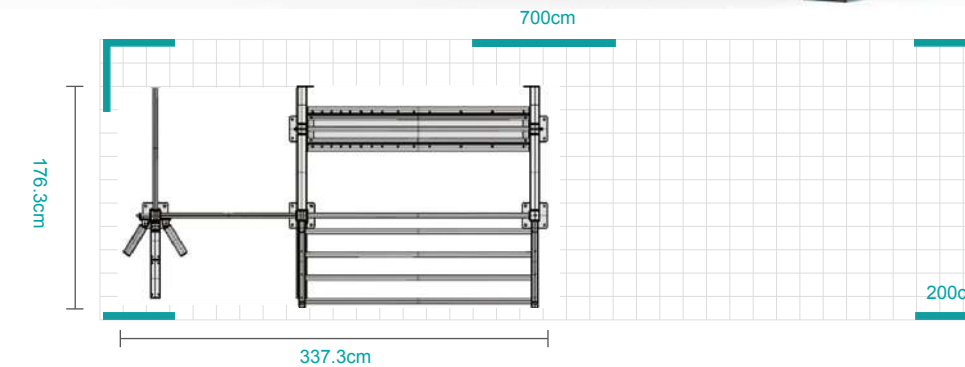

FEATURES :

1. Modular configuration and future expandability
2. Interchangeable, quick-change shelving system
3. Freedom mount technology
4. Custom color
5. Custom logo

CUSTOMIZATION :

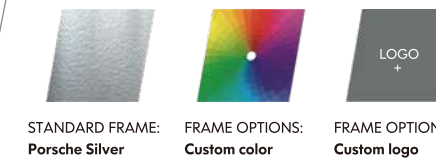

Size of equipment:
337x176x280cm

Training Area:
700x200cm

GS-PTF PERFORMANCE TRAINING FRAME

Email : sales@liveupsports.com
Phone : 0086-513-81180020

LIVEPRO
LIVEPRO HEALTH-TECH CO.,LTD



Customized storage and suspension system

www.livepro-fitness.com

FUNCTIONAL OCCUPANCY
6-8
USERS

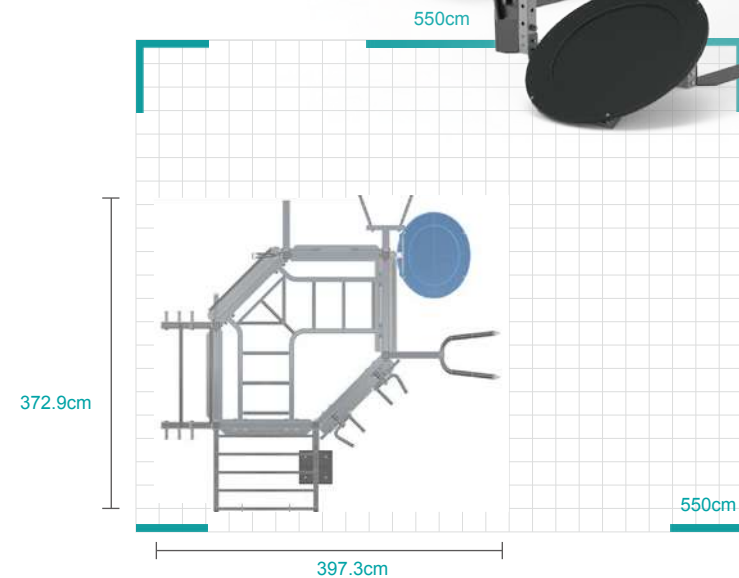

GAIN[S] is LIVEPRO's new storage solution brand. Today, the motion space has diversified dimensions and designs, but to realize the function of space utilization and exercise maximization effectively is their common goal. Equipment placement, safety and space saving are significant. Gain[S] system can keep storage while activating other systems. Gain[S] storage and suspension system adopts modular design, which is perfect for group studio, dynamic training area and private extension area.

PRODUCTS REFERENCE :

- | | |
|--------------------------|-----------------------------|
| 1. BASE FRAME (X1) | 12. MEDICINE BALL TRAY (X1) |
| 2. BAR HOLDER (X1) | 13. MULTI-GRIP CHIN UP (X2) |
| 3. BAND PEGS (X2) | 14. BALL REBOUNDER (X1) |
| 4. BALL THROW (X1) | 15. SAFETY CATCHES (X1) |
| 5. DIP STATION (X1) | 16. SINGLE PULL UP (X1) |
| 6. DOUBLE PULL-UP (X1) | 17. PLYO STEP (X1) |
| 7. FLYING PULL UP (X1) | 18. SUSPENSION RINGS (X1) |
| 8. HEAVY BAG (X1) | 19. T-BAR ROW (X1) |
| 9. HEAVY BAH HANGER (X1) | 20. U-LINK (X1) |
| 10. KETTLEBELL TRAY (X1) | 21. WEIGHT PLATE HORNS (X1) |
| 11. LIFT OFFS (X2) | |



FEATURES :

1. Modular configuration and future expandability
2. Interchangeable, quick-change shelving system
3. Freedom mount technology
4. Custom color
5. Custom logo

CUSTOMIZATION :

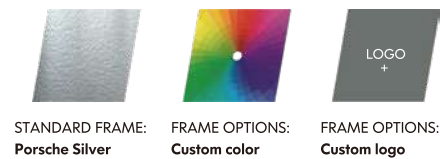

Size of equipment:
372.9x397.3x335.6cm

Training Area:
550x550cm

**GS-CTF-HEX
CROSS TRAINING FRAME**

Email : sales@liveupsports.com
Phone : 0086-513-81180020

LIVEPRO
LIVEPRO HEALTH-TECH CO.,LTD